



2026  
EDITION

# GRANITE DESIGN

## Stone Reference Guide

# table of CONTENT

[ helping you find the answers to your questions ]

## GENERAL INFORMATION

A word from our President	1	FAQ	10	Symbol Chart	4
After we leave	10	Granite Design Order Process	5	The Granite Design Difference	2
Being Ready for Installation	9	HybriQ Technology	44	The Origin of Stone	14
Being Ready for Template	8	Our partners Cosentino	44	Understanding Scheduling	6
Dekton - Exploring the limits	80	PerfectF.I.T.™ Process	16		
Fabrication - our video capsules	15	Preparing customers for next step	7		

## THE STONES

Arga (Dekton)	68	Neural (Dekton)	73	Commercial Collection	57
Blanc Elysée (Silestone)	48	Persian White (Silestone)	52	Dekton Collection	76
Bronze Rivers (Silestone)	50	Rem (Dekton)	65	Natural Stone Collection	42
Calacatta Gold (Silestone)	49	Siberian (Silestone)	54	Quartz Collection	56
Cambrian Black (granite)	24	Sirius (Dekton)	70		
Ethereal Glow (Silestone)	53	Soapstone (steatite)	35		
Fantasy Brown (dolomite)	39	Statuario (Silestone)	51		
Helix (Silestone)	55	St-Henry (granite)	25		
Itara (quartzite)	31	Trance (Dekton)	66		
Kelya (Dekton)	64	Valle Nevado (granite)	26		
Laurent (Dekton)	67	Via Lattea (granite)	23		
Marina (Dekton)	69	Waterfall (granite)	27		
Morpheus (Dekton)	72				

## SINKS

Sinks - Custom Built	97
Sinks - Integrity	97
Sinks - Stainless Steel	96
Vanity Sinks - Custom Built	98
Vanity Sinks - Porcelain	98

## OPTIONS

Arcs & Bumpouts	90	Outdoor Kitchens	94
Backsplashes	88	Overhangs	90
Brackets & Other supports	91	Radius Corners	89
Chip Minimizer	85	Seam Smoother	86
Drainboards	87	Stone Care Kit	84
Edge Profiles	92, 83	Surface Covering	84
FreePower Charging Station	99	Surface Rip Down	86
GDGuard Stain Protection	85	Ukiyo Texture	99
Layout	93	Undermount Cut-Out	87
Mineral Oil Option (soapstone)	35	Undersurface Polishing	92
		Vein Flow	92
		Waterfall Legs	91

## WARRANTIES & CARE

Seam Performance	86, 104
Undermount Sink Installation	104
Warranty Overview	104
Caring for Dekton	62
Caring for Granite	22
Caring for Marble	38
Caring for Quartzite	30
Caring for Silestone	49
Caring for Soapstone	34

## TECHNICAL INFORMATION

Advantages of Dekton	61	Etching	20, 37
Advantages of Natural Stone	19	Installing Full Height Cabinets	102
Advantages of Silestone	45	Material Comparative Table	103
Average Slab Dimensions	100	Microfissure	20
Calculating Linear Footage	100	Natural Characteristics	20
Calculating Square Footage	100	Pitting	20
Dekton - Cabinet Supports	78	Roudness and Stone	40
Dekton - Cut-Outs	79	Seam - Type & Placement	101
Dekton - Edge profiles	60, 72, 76	Silestone - Fabrication process	47
Dekton - Inside Radius	79	Sinks - Choosing the right one	95
Dekton - Seams	75	Standards - countertop installation	102
Dekton - Sintering Technology	63	Surface Hardness Scale	101
Dekton - Ukiyo Texture	77	Understanding Granite	21
Dekton - Variable Pattern	78	Understanding Marble	36
Dekton - Waterfall Legs	79	Understanding Quartzite	29
		Understanding Soapstone	33
		Variance in Shine	20

Our Story

# GRANITEDESIGN

[ we are so much more than square footage ]

**1998**

A vision is born. The desire to create something tangible leads to the founding of the company in a small residential garage in Ayer's Cliff.

**1999**

Already operating at full capacity, the company relocates to a 5000 sq.ft. facility in the border town of Stanstead. The first employee is hired to operate the very first saw.

**2001**

Agenda is introduced; a custom-built order management software designed specifically to meet the company's operational needs.

**2004**

The growing popularity of Silestone quartz by Cosentino, then an exclusive product for **GRANITEDESIGN**, fuels rapid growth, leading to four expansions of the canadian facility.

**2005**

The company relocates its canadian operations to a new 20 000 sq.ft. facility, and in the same year, expands in Manchester, NH.

**2006**

Granite Design moves the Manchester, NH operations to Derby Line, VT.

**2013**

The company celebrates its 15th anniversary in style with a new logo.

**2015**

Granite Design moves to a larger location in Derby Line, VT.

**2016**

Manufacturing automation begins in the canadian facility with the introduction of a Kuka robot and two Breton dual-head saws (radial saw and waterjet) on an interchangeable table system; a production line that still stands out globally today.

**2018**

For its 20th anniversary, the company invests \$4.1M in plant expansion, new equipment, new modern offices, new location in Maine, along with the transformation of the Agenda software into a technologically advanced platform known as "Synergy."

**2019**

The company's core values are formally defined: TEAMWORK, PRIDE, and PERFORMANCE; guiding every action and decision.

**2025**

Automation continues within the Synergy management system, now a robust, multi-layered ecosystem that enables full traceability of every unique project. The company also expands its operations in Bangor, ME.

**2026**

A new Kuka robot and CNC machine is added to our Vermont Facility, increasing our production capacity.



## A word from our president **JONATHAN VANASSE**

From the very beginning of my career, I always knew I wanted to **build, shape, and create with my own hands**. More than that, I wanted my work to give life to something beautiful and lasting.

As a teenager, my first job was shaping headstones and elements for landscaping projects. I was quickly fascinated by this industry, but I dreamed of going further. I aspired to use this noble material to **transform living spaces and improve people's everyday lives**.

In 1998, the granite countertop market was still in its infancy. Most households opted for laminate countertops—until a hot pan inevitably revealed their limitations. I saw an opportunity. I crafted my very first granite countertop by hand in my garage. The effort was colossal, but the result was spectacular. That was the moment I was hooked.

More than twenty-seven years later, that passion remains intact. What still drives me today is the same desire to **innovate and bring beauty into our clients' daily lives**. To achieve this, I continually stay attuned to new materials, emerging technologies, and trends that are reshaping our industry.

Those who have visited our Stanstead facility know that I have never been afraid to think bigger. My only true constant is **change** and it is precisely this mindset that allows us to remain at the forefront of our field.

Of course, none of this would have been possible without the talent of my teams and the trust of our valued distributors. It is for you, and thanks to you, that this **Stone Reference Guide** came to life. I am proud to share this collection of knowledge, designed to nurture your expertise and fuel your passion.

I invite you to explore it with curiosity, draw inspiration from it, and share your suggestions with us. Because an open, eager-to-learn mind is the greatest driver for pushing boundaries.

**Enjoy your reading!**

  
JONATHAN VANASSE, PRESIDENT



Our strengths at  
**GRANITEDESIGN**



**SOLIDE PARTNERSHIPS**

with key industry players and suppliers.  
[ ensuring a varied & competitive supply ]



**TALENTED TEAMS**

driven by precision, with a passion for  
stone coursing through their veins.  
[ ensuring high quality fabrication ]



**GRANITEDESIGNUSA.COM**

VERMONT | NEW HAMPSHIRE | MAINE | **1-866-761-8700**



### A PROCESS

of fabrication & order management that is innovative, structured & efficient.  
[ making high volume production a breeze ]



### CERTIFIED

by leading professional associations & BackChecked™ certified technicians.  
[ for a spotless reputation ]

# A brief overview IN NUMBERS

+ 150  
employees

+ 300  
installations  
per week

+ 7 500  
miles travelled  
per week

# understanding the **SYMBOLS**









## FINISHES

Each stone is available in certain finishes.

- P** Polished
- H** Honed
- A** Antique
- B** Brushed
- S** Suede
- V** Velvet

## RESISTANCE

Materials are resistant to elements, but NEVER bulletproof.

-  Stains
-  Scratches
-  Heat
-  Temperature Change
-  Acid
-  Abrasion
-  High Heat
-  Highly Scratch Resistant
-  UV Rays

## CHARACTERISTICS

Different materials are subject to unique characteristics.

-  Microfissures
-  Etching
-  Pitting
-  Variance in shine
-  Sensitive to scratches
-  Handle with care
-  Requires frequent cleaning
-  Possible break in pattern
-  Edge with solid color & honed finish

## GDGuard™ TREATMENT



Stones that are identified with this symbol will benefit from our exclusive long-lasting anti-stain treatment that comes with a **15-yr warranty against food & beverage stains** (valid on granite & quartzite only).

Make sure to offer the treatment when recommended!

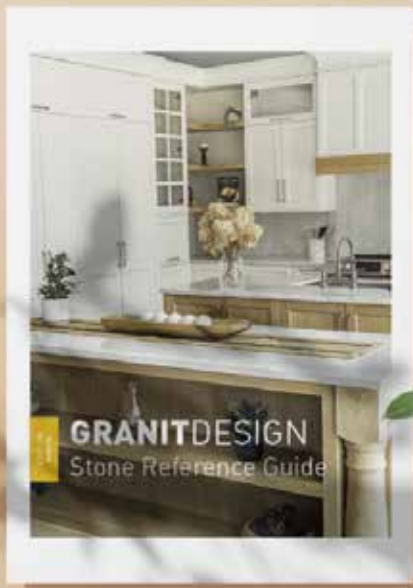

# The process at GRANITEDESIGN



## Updates

Additional communications can be sent to inform of changes at any step.

## REGULAR PROCESS

When cabinets are in place at measuring.

## PerfectF.I.T.™ PROCESS

When cabinets & countertops are fabricated at the same time.



Applies to PerfectF.I.T.™ projects



Common

Send order with full plans, accessory technical specs and DWG.

Analysis & approval step for the PerfectF.I.T.™ project



### Project Opening & full review

Provide anticipated cabinet delivery & installation date

Route Logistic Analysis to obtain best template date

Wall Template date confirmation for **(NO cabinets are in place)**



Template Date confirmation **(on cabinets already installed)**

Technicien visits to perform wall template

Technician visits to perform measure

Granite Design sends cabinet installation plans to the cabinet fabricator

### Material is purchased

Cabinet fabricator informs Granite Design of cabinet fabrication progress.

Material inspection

Production planning

Route Logistic Analysis to obtain best installation date



### Countertop Installation Date confirmation

Cabinet fabrication done as per final plans

### Countertop Fabrication

Quality Audit

Packaging

Cabinet Installation dby the cabinet fabricator done according to installation plan provided by Granite Design



### Countertop Delivery & Installation





You're eagerly looking forward to the full completion of your construction or renovation project. The countertop is a key milestone in making your space fully functional and we're just as excited as you are to be part of it!

## Understanding **CUSTOMER READY DATES**

During our initial discussions with customers, our team verifies when the space will be ready to receive our technicians. **The date noted at that time serves as a starting point for our logistical planning.**

**It's important to understand that this date is not a confirmed appointment,** but rather the moment from which our team begins assessing availability in that area in order to propose the **best possible date.** With over 300 installations per week distributed across roughly thirty technician teams, our automated logistics system acts as a true conductor, evaluating and confirming each appointment to better serve our customers.

If vacations, meetings, or travels are planned around that period, simply let us know; **we will adjust the schedule to ensure everything takes place at the most convenient time for the customer.**



*a date proposal*  
**is sent 7 business days  
prior to the appointment  
date.**



© Photo: Granit Design

# Being well prepared **FOR STEPS TO COME**

The planning phase of your project is now complete: you've carefully considered every detail that will bring your new space to life. The next step is to properly prepare for the arrival of our teams, first for the measuring appointment, then for the installation of your stone surface, custom-crafted just for you.

At **GRANITEDESIGN**, our mission is to master the art of creating beauty tailored to you. This passion guides everything we do. To achieve this, we prioritize **the safety and well-being of our teams, innovation, and the talent of our people.**

That's also why we've developed a **rigorous structure and proven work methods**, which, combined with the creativity of our design partners, allow us to create unique environments that reflect each client's personality. Every project, every stone, and every space tells a story of its own.

As a designer, informing your client about what to expect is the key to a smooth and enjoyable experience.

As a client, your presence at appointments and your involvement are essential. No question is too small, and we're here to answer them.

In the following pages, you'll find **what needs to be prepared for each appointment.**

Questions? Need clarification?

**GRANITEDESIGNUSA.COM**

1-866-761-8700 | or chat online with us !

# Being ready FOR MEASUREMENTS

When your project is open, our team takes care to confirm with you the date from which we will be able to visit the site to take measurements for the countertops. **It's important to note that this date is not a confirmed appointment**, but rather the point from which our team will begin assessing availability in the area in order to propose the **best possible appointment**.

If vacations, meetings, or travels are planned around that period, simply let us know; **we will adjust the schedule so everything takes place at the most appropriate time.**



## TO VALIDATE PRIOR TO OUR ARRIVAL

- THE SITE**  
is safely accessible (depending on the season, this may involve shoveling snow, removing ice, etc.)
- CABINETS ARE INSTALLED**  
are level and plumb, and structurally compliant (except for PerfectF.I.T.™ projects)
- EXISTING COUNTERTOPS**  
can be in place, but **free** of any object.
- ACCESSORIES ARE ON-SITE**  
sinks, faucets, stove/cooktop, soap dispenser, overhang brackets, etc.
- APRON (FARMER) SINKS**  
is in its place in the cabinet, but not permanently fixed.
- PRICES AND FINAL DETAILS**  
are confirmed at measure. **A decision-maker must be on-site to approve final plans.**



SCAN  
to see the  
measure process



# Being ready **FOR INSTALLATION**

The measuring phase is complete, the final plans align with your expectations, and our team will now schedule the material in sufficient quantity to craft your project. Once the material is on hand, it is carefully inspected. Following this inspection, our planning team can schedule fabrication, packaging, and installation. It is from this point that the **logistics planning team will determine and offer the best possible installation date.**

If vacations, meetings, or travels are planned around this time, simply let us know; **we will adjust the schedule so everything takes place at the most convenient time.**

## TO VALIDATE PRIOR TO OUR ARRIVAL

- THE SITE**  
is safely accessible (depending on the season, this may involve shoveling snow, removing ice, etc.)
- CABINETS ARE INSTALLED**  
are level and plumb, and structurally compliant. **GRANITEDESIGN** is not responsible for the cabinet's condition underneath the existing countertops. The new countertop is placed on the existing structure.
- EXISTING COUNTERTOPS ARE REMOVED**  
unless the Removal & Haul Away Service is added to the project.
- SUPPORTS**  
for overhangs (i.e.: lunch bar) are fixed to the bottom cabinet (if applicable).
- FLOORS ARE PROTECTED**  
either with cardboard or tarp fixed to the ground with adhesive tape, etc.
- APPLIANCES ARE PROTECTED/REMOVED FROM INSTALLATION AREA**  
The stove must be removed from its location, and you can protect fridge doors, etc.
- THE CABINET BELOW THE SINK IS EMPTIED**  
if you have selected an undermount sink model.
- ACCESSORIES ARE ON-SITE**  
faucets, sinks, soap dispenser, food grinder, etc. Everything must be on-site, near the installation area.



# What you will do **AFTER INSTALLATION**



Our technicians are mindful of the installation site and will leave it in a broom-clean condition. Material is heavy, **any accidental damage** linked to material handling is **not** covered by **GRANITEDESIGN**. This includes but is not limited to damaged walls, hallways, floors, doors, appliances, etc.

## You will need to :

- **RECONNECT plumbing & other services**  
Particularly undermount sink; as a **wait time of 24 hours** is required before reconnecting. The customer must also coordinate reconnecting other services (gas, electricity, etc.) and install faucets, food grinder, dishwasher, etc.
- **CLEAN the space**  
Our technicians will remove trash caused by the installation and will broom, but the installation site is considered a construction zone; residual dust/snow/mud that is tracked in or created by tasks performed during installation are to be expected.
- **SILICONE FINISHING**  
The technician does not apply silicone for TOP MOUNT (drop in) sinks. The technician can apply, to his discretion, a first coat of silicone between the countertop and the wall, but a 2nd coat will be required and will be applied by the customer. When requested, our silicone caulking (**non-paintable**) is **not considered a seam and is not covered by the one-year warranty offered by GRANITEDESIGN**.

## Frequently Asked **QUESTIONS**

### At what time is my appointment?

We confirm tentative ARRIVAL times 24h prior to the appointment.

### Will my floor be dirty?

Our technicians wear safety boots that can track in mud, water, and snow. Protect your floors in a way that will be safe for our technicians.

### I can feel my seam. Is that normal?

Yes. Seams are always visible and can be felt, even when they are done with the utmost care.

### Can my countertop be repaired?

Yes, in most cases. Contact our teams for more details.

### Can my countertop contain radon?

Yes, but in very small quantities, less than 1 millionth, thus negligible.

### What is a thermal shock?

It is when a hot element comes in contact with a cold stone surface, creating stress in the

stone. Always use a trivet to avoid this.

### I see rust-like stains in my countertop, is that normal?

Natural stones can undergo slight oxidation, as it is exposed to water. For manufactured stones, this phenomenon is mostly limited to the sink surround area.

### What are the Granite Design Warranties?

Granite Design offers a 1-yr warranty on seam and undermount sink performance. If you choose a natural stone that is protected with our exclusive GDGuard™ treatment, Granite Design offers a 15-yr warranty against food & beverage stains, applicable to treated granites & quartzites.

There is no warranty that will protect any stone against chips, but the Chip Minimizer Upgrade will considerably reduce the risk of chips in the area most prone to this; the sink, think of offering it!





creators of  
**LIVING SPACES**

Quartz Countertops | Fabrication & Installation : Granite Design | © Photo : Granit Design

For nearly 30 years, we have been proud to craft unique projects from the finest materials.

With over 160,000 projects completed, **GRANITEDESIGN** transforms spaces into living environments that reflect each client's identity.

Ask yourself: what would a space be without a countertop? Could you host family and friends without this central element around which everything revolves? [Especially at the island!]

And without a countertop... no sink. And what can you accomplish without a sink? [Not much.]

This simple observation highlights the importance of working with a manufacturer who understands your reality, delivers to expectations, and supports every designer in their vision.

As a designer, you know it: a countertop is not just an accessory. It is a **centerpiece**, custom-made to reflect your project. **It deserves time, care, and expertise at every step to ensure its quality.**

The world of custom work also means learning to navigate the unpredictable! The experience of our teams minimizes the impact of unforeseen challenges, and the collaborative spirit we share with you, our valued partners, takes care of the rest. After all, we share a common goal: **complete client satisfaction.**

By combining our strengths, manufacturer and designer, we pursue a single **mission: to be masters in the art of creating made-to-measure beauty.**



**Beyond color and trends,** *RECOMMENDING* a material suited to the client's lifestyle is key.

**Asking bold questions about daily habits guarantees long-term satisfaction.**



*You have a question?*  
**Contact us to increase your knowledge base on stone!**



*Maintain an objective approach.*

**Every project is an opportunity to broaden your horizons and better understand your clients' tastes and needs.**

Perhaps Soapstone isn't your favourite material, but if your client appreciates it and understands its characteristics, seize this opportunity to deepen your knowledge and enrich your expertise with a stone you encounter less often.

*Let's create together*  
with **A SENSE  
OF ZEN**



## Mother Nature is the creator

of all granites, marbles, soapstone and quartzites [basically, all natural stones]. She creates each stone unique and perfectly imperfect! Before arriving at our facility, the stone is :



**QUARRIED**  
in the  
soil using  
explosives  
or diamond  
saws.

**CUT**  
into blocks.

**CUT (again)**  
in slabs,  
which can  
take up to 3  
days.

**POLISHED**  
to the finish  
that is sold  
on the  
market.

See how it is  
made!



# NATURAL

## The origins OF STONE

Selon le type de pierre ou encore la marque, cette réponse va varier. **GRANITEDESIGN** travaille avec des fabricants et importateurs de pierres de renom, tels que **COSENTINO**, qui sourcent leurs tranches aux quatre coins du globe. Le Brésil, l'Espagne, l'Italie, l'Inde et le Québec (oui oui, le Québec!) sont les berceaux les plus populaires.

# MANUFACTURED



See how  
Dekton® is  
made!



## Humans are creators of

mineral and ultra-compact surfaces (like Dekton®). Similar to making a cake, a preparation of quality minerals, pigments and bonding agents is combined, depending on the stone, followed by a moulding, decorating, cooking and cooling process, to create a wide array of nature-inspired patterns.

There is not one identical slab, but the look is fairly consistent between each production.





## Learn more **ABOUT FABRICATION**

**Our capsules**  are ideal for understanding each fabrication step.

### **INSPECTION**

[see how  
stone is  
evaluated]



### **THE FIRST CUT**

[did you know  
we have a  
robot?]



**CNC  
MACHINING**  
[each project  
goes through  
our CNC]



**FINAL CARE**  
[the last steps  
of a project]



## What it looks like **15 DAYS OF STOCK?**



### **[ And it's quick to go ]**

With the volume that is required to supply all our distributors, **GRANITEDESIGN** orders and receives material for your projects on average **13 to 15** business days prior to the anticipated fabrication date, which is on average about **10 days** prior to the planned installation date.

# Why offer the PerfectF.I.T.™

To have your countertops installed  
1 business day after your cabinets.



You **save** time



You **regain the comfort** of your home  
quicker



You obtain a product that respects the  
**same high quality standards**



You benefit of an **exclusive high-end  
service**, reserved for our top partners

**PerfectF.I.T.™, precision at the core of each project.**

Inspiring the industry yet unmatched in execution, PerfectF.I.T.™ embodies excellence in precision and coordination. With our state-of-the-art laser wall measuring technology, we ensure an extraordinary level of accuracy for every countertop.

**In collaboration** with cabinet manufacturers renowned for their rigorous processes and experienced installation teams, we provide **complete synergy** between fabrication and installation.

With PerfectF.I.T.™, countertop and cabinet production occur simultaneously, thanks to advanced technical planning conducted by our specialized team. They analyze and validate cabinet installation plans, ensuring exemplary project engineering coordination and optimized panel placement **for a truly perfect fit.**

INSTALLING COUNTERTOPS  
**THE NEXT DAY**  
after cabinets are fully installed



Learn more!



© Photo : Interior Designer Elaine Roux  
Countertops : Sillesstone® Lime Delight  
Templated, fabricated & installed Granit Design in PerfectF.I.T.™

# concretely, **WHAT DOES IT ENTAIL?**

**Our PerfectF.I.T.™ rests on a tight collaboration and meticulous preparation from the get-go. Because it is not the simple method of fabricating from your plans!**

Before the wall template appointment, make sure that :

- ① Walls are final (gyproc and plaster).
- ② Walls are clean and do not have any damage.
- ③ The space is cleared to allow our laser to capture every detail.

Once the wall template is done, our team sends the cabinet installation **plan to the cabinet fabricator**, which must be followed with great care to ensure an impeccable fit with our countertops.

**Result: a fluid process, a fast installation; a highly satisfied customer!**



© Photo : Granit Design - wall measure



© Photo : Interior Designer Elaine Roux



© Photo : Granit Design - countertop installation



# NATURAL STONES

# Why CHOOSE Natural Stone

Material authenticity, beauty, durability and heat resistance are the main advantages that put natural stones to the forefront for any design.



Unique appearance, each slab is a master piece that will evolve with you



Higher resistance to heat compared to laminate or quartz countertops



Stain resistant with a 15-yr warranty against food & beverage stains\*  
(on granite & quartzite treated with our exclusive treatment offered by **GRANITEDESIGN**)



Scratch resistant  
(except for Soapstone)



Easy to maintain when treated with the exclusive treatment offered by **GRANITEDESIGN**, no sealer required after installation



Can be used indoor and outdoor

\* The warranty on the exclusive treatment offered by **GRANITEDESIGN** is applicable to surfaces in granite or quartzite, and protects against food & beverage stains. There is no warranty that protects a stone surface against natural characteristics (microfissure, pitting, etching, etc.) or against chips.

# Understanding characteristics and Natural Stones

© Photo : Granite Design - Taj Mahal Quartzit, Antique finish | Template & Installation : Granite Design

Most Frequently  
Observed in :



## MICROFISSURES

More commonly found in exotic natural stones, microfissures are ancient fractures that are sealed over millions of years under the influence of heat and extreme pressure within the earth. These fissures allowed water to penetrate, giving the stone its distinctive coloration and unique veining, before closing again to create a one-of-a-kind surface. **Such stones must be handled with care.**

- ✔ Quartzite
- ✔ Marble
- ✔ Dolomite
- ✔ Granite



## VARIANCE IN SHINE

Often found in exotic stones composed of an amalgamation of minerals with varying levels of hardness. Softer minerals (e.g., mica) react differently to polishing, **creating more matte areas that highlight the stone's natural richness.** Much like rubbing an apple versus an orange on your sweater: although both are fruits, an orange (softer) will never shine like an apple (denser)!

- ✔ Quartzite
- ✔ Marble
- ✔ Dolomite
- ✔ Granite



## PITTING

The term refers to the presence of small, superficial craters. This is not a defect, but rather the result of tiny air pockets separating different minerals, causing the "weaker" minerals (e.g., biotite) to lift from the surrounding surface and leave behind very small craters that can be felt to the touch. **The quality and durability of the stone are not affected.**

- ✔ Granite



## ETCHING

This refers to the dulling of marble when it comes into contact with acidic foods. Many edible and household products can cause this phenomenon (lemon or orange juice, sauces, coffee, wine, bleach, etc.). It may resemble a "ring" or stain, but it will feel rough to the touch. Repolishing can help correct the issue. **Choosing a matte finish will reduce the appearance of etching.**

- ✔ Marble
- ✔ Dolomite



© Photo : Granite Design - Absolute Black granite

# Understanding Granite

## Granite, the Strength & Beauty of Nature.

Born from the heart of the Earth, granite formed millions of years ago through the cooling and solidification of magma. Composed primarily of quartz, feldspar, mica, silica, and oxidized minerals, it embodies the raw power of geology.

Its spectacular colors are the result of water interacting with minerals over time. This is why each region of the world offers granite with unique tones and variations.

**Canada** is renowned for its exceptionally deep black granites, such as Cambrian Black or Saint-Henry, featuring complex and refined mineral structures.



**Brazil and India**, meanwhile, are celebrated for granites with diverse palettes, ranging from warm hues to cooler tones, each with a distinct character.

### Why choose granite?

Choosing granite means opting for uniqueness, durability, and timeless beauty. It is an invitation to incorporate into your project a stone shaped by the Earth itself—bringing strength and character, along with subtle natural traits that may require flexibility in scheduling depending on the selected stone, yet are part of its undeniable charm.

## THINGS TO CONSIDER before choosing granite

The beauty of granite lies in its authenticity. This natural richness comes with unique characteristics:

-  **Microfissures** : witnesses to its formation, they enhance the veining but may make the stone more fragile prior to installation.
-  **Pitting** : tiny cavities resulting from quarry polishing, perceptible both to the touch and to the eye.
-  **Variance in shine**: a stone with a high presence of softer minerals (e.g., mica) will display matte areas, visible from certain angles.

Finally, its **uniqueness** must be considered. Each slab is a work of art created by nature. What you see in the showroom or in a magazine will never be identical to the stone chosen for your project.

# for these oops moments! [on your granite countertops]



## DAILY CARE



Warm water



Gentle soap



Microfiber Cloth



Use Trivets & Cutting Boards

## A FEW TIPS for your granite countertops!

Because the bulletproof /stain proof stone is not invented yet, here are a few useful tricks!



### ORGANIC SOURCES

[food colorant, spices, wine, mustard, coffee, etc.]

Cover the area with a paper towel, exceeding the zone about 1 inch all around. Pour a 50/50 dilution of bleach and water on the paper towel. Cover with a plastic wrap and seal the edges with painting tape. Let sit 24 hours. Remove and rinse thoroughly. Let evaporate (2 to 3 days). If the situation persists, use the method for red wines.



### METALLIC SOURCES

[scrapes made with belt buckle abrasion, residues left by pots/pans, etc.]

Cover the area with a paper towel, exceeding the zone about 1 inch all around. Pour CLR on the paper towel. Cover with plastic wrap **without** sealing the edges. Let sit 1 hour, rinse with hot water. Then, use a magic eraser soaked with CLR, scrub the area in circular motions with light pressure. Rinse with hot water, dry completely with clean microfiber cloth.



### RED WINE

[residue often pinkish, a bit tacky]

Pour the product "Red Wine Stain Remover" on the area and follow the instructions on the package. Rinse and dry completely with a clean microfiber cloth. If the situation persists, repeat but with Peroxyde Vol. 40. Let sit 2 hours (or more). Rinse and dry completely with a clean microfiber cloth.



### OILS & FATS

[residue that will darken the stone in certain areas or the entire surface]

Mix baking soda and water to create a paste. Spread on stain, about 1/4 inch thick. Cover with plastic wrap, and seal edges with green paint tape. Leave for 24 to 48 hours. Remove using clean microfiber cloth and warm water. If the situation is resolved, apply a sealer. If it persists, consult our experts.



### AVOID

#### SPONGES

Abrasive products

Acids

Chemical products & bleach

Wax or any other polishing product

**VIA LATTEA (granite)** | Brazil | Slab ≈ 130 x 75

This black granite from Brazil offers a rich and mysterious ebony background with subtle veins in shades of ivory, eggshell and soft caramel. Its mineral composition includes schist, which adds sparkle and depth to the stone.



**Characteristic**



**Variation**



Layout strongly recommended

**Finish**



**Resistance**



**Thickness**

1 1/4"

**Applications**

indoor

outdoor

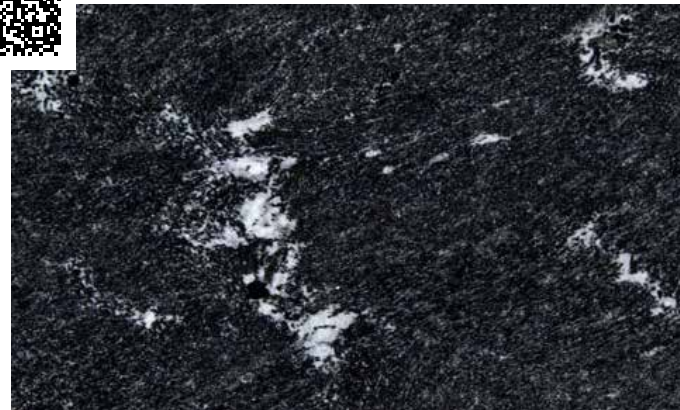

Our favorites  
**of our collection**

The result of our collaboration with Cosentino, **GRANITEDESIGN** presents a collection of natural stones that embody **elegance, authenticity,** and the **beauty of the material in its purest form.** Turn to page 42 to discover its full richness.

*Beautiful,*

these stones are unique focal points. When paired with rich tones, they create elegant designs that do not go unnoticed.



Champagne

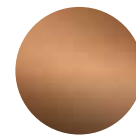

Bronze



Raven





**CAMBRIAN BLACK (granit)** | Canada | Tranche ≈ 125 x 72

This Canadian classic quarried in Quebec is the little black dress of the stone industry. Elegant, timeless and authentic, it is one of the rare black natural stones that requires **no resin or dye** to maintain its rich tones. Its pure composition makes it ideal for several application types, and the antique finish enhances the stone's natural beauty.

Characteristic



Variation



Layout not recommended

Finish



Resistance



Thickness

1 1/4"

Applications

indoor

outdoor

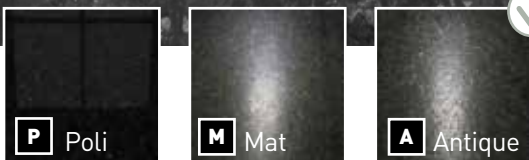
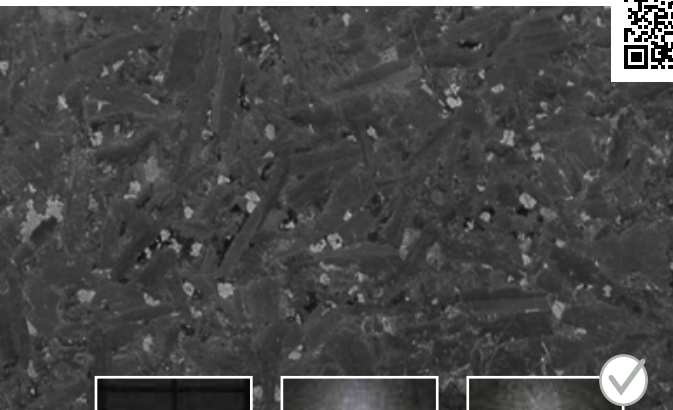

the importance  
**of finish**



With darker granites, **oily residues will be more visible on polished and honed finishes.** The **antique** finish will create a unique texture and will dissimulate these residues better!



**ST-HENRY (granite)** | Canada | Slab ≈ 120 x 72

This granite is a sophisticated stone quarried in Quebec. Its dark tones blend blacks, blueish greys and rich browns to create an elegant look that withstands the test of time.

In a **polished** finish, this stone will be darker, whereas with a **honed** or **antique** finish, its tones will be paler, closer to a steel grey, but its texture will be more unique and complex.

<b>Characteristic</b>	  
<b>Variation</b>	 Layout not recommended
<b>Finish</b>	
<b>Resistance</b>	  
<b>Thickness</b>	1 1/4"
<b>Applications</b>	<b>indoor</b>   <b>outdoor</b>



© Photos : Granite Design - granite St-Henry Antique

*Beautiful,*

these stones are unique. Paired with rich and authentic tones, they create modern and dynamic designs.

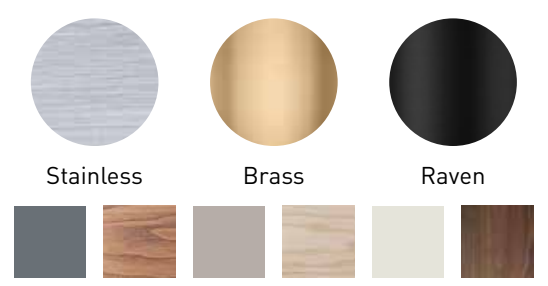



**VALLE NEVADO (granite)** | Brazil | Slab ≈ 116 x 68

This timeless granite detains a mineral structure that includes feldspar and natural quartz, which adds depth and translucency to the stone.

Ferrous intrusions in the earth created small rust colored crystals, which contrast and enhance the stone's paler cool white and taupe shades.

**Characteristic**



**Variation**



Layout available

**Finish**



**Resistance**



**Thickness**

1 1/4"

**Applications**

indoor

outdoor



## pitting and granite

These small craters are created when the stone block is cut into slabs and undergoes the initial polishing stage.

They are not defects and cannot be filled with external agents in a durable fashion. This characteristic contributes to a stone's uniqueness, without impacting its beauty or durability. See page 20 for more details.



**WATERFALL (granite)** | Brazil | Slab ≈ 120 x 72

The richly marbled veining of charcoal, ink, silver and dove gray fall across a snow white background. Waterfall makes a design statement.

Characteristic



Variation



Layout strongly recommended

Finish



Resistance



Thickness

1 1/4"

Applications

indoor

outdoor

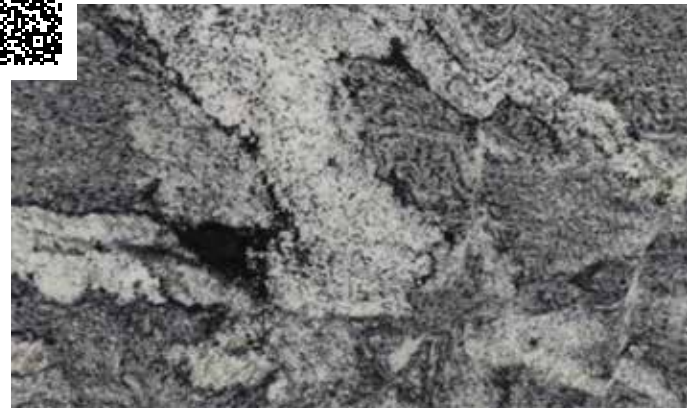
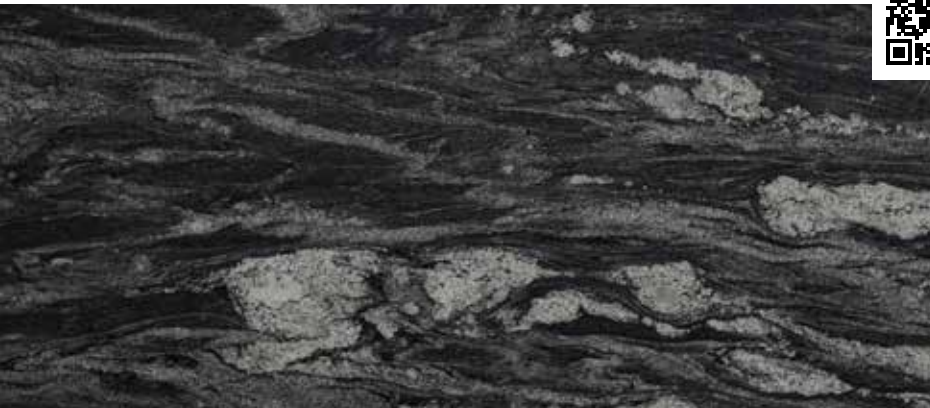

*Beautiful,*

these stones are unique. Paired with rich and authentic tones, they create modern and dynamic designs.

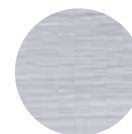

Stainless



Brass



Raven





**BIANCO ANTICO (granite)** | Brazil | Slab ≈ 120 x 70

Bianco Antico is extracted in the state of Ceara in Brazil, renowned for the beauty of its wild beaches and warm tropical climate.

The granite has predominant hues of whites and greys, with taupe and bordeaux tones in its movements. The quartz crystals are clear, adding to this stone's depth.

Resin and mesh are added to the stone, making it safer to handle. This comes with certain limitations in fabrication, but a carefully designed project will create an elegant result.

**Characteristic**



**Variation**



Layout strongly recommended

**Finish**



**Resistance**



**Thickness**

1 1/4"

**Applications**

indoor

outdoor



*Beautiful,*

These stones are timeless classics. Paired with warm tones, they are incredibly versatile.



Stainless



Brass



Raven





© Photo : COSENTINO - quartzite Itara

# Understanding Quartzite

**Quartzite is a natural stone quarried in the ground.** Formed millions of years ago, it is the result of sand, colored by oxidized minerals, that is subjected to incredible heat and pressure in the Earth. The result? A dense, spectacular and unique stone, with soft veins similar to marble, but with resistance levels that are closer to granite.

### Quartz vs. quartzite : two names, two realities.

Do not confuse these similar names - quartz and quartzites are two materials that originate from different sources, with properties that are radically different.

**Quartz** is the popular term for a manufactured stone sold by leading brands such as Silestone® by Cosentino. Its name is derived from one of its main ingredients: natural quartz, these white rocks found in nature. When combined with pigments and resins, it creates a homogeneous, durable and easy to care for surface.

### So why choose quartzite?

For its pure **authenticity** and its unmatched beauty. This quality also means that each project will require **more care, flexibility and patience**. It is a material that must be earned... but well worth it!

## THINGS TO CONSIDER before choosing quartzite



**Microfissures** : natural heritage of its geological formation, quartzites are filled with old fractures. They allowed the rich tones that color the stone, but also contribute to its fragility - especially the steps leading up to the final installation.



**Its exotic nature** : the stone's density and presence of mesh on its back can limit edge selections, maximum dimensions, the possibility to make the stone thinner, and can even lead to breakage during fabrication.

**Finally, the aspect of slab uniqueness** : what is possible for one project may not be possible on another. Each quartzite slab is a unique masterpiece, signed by Mother Nature - and sometimes, she has a few surprises up her sleeve.

Photo above : Itara quartzite - Cosentino.  
Photo below : Microfissure in the Taj Mahal quartzite



for these  
**oops moments!**  
 [on your **quartzite** countertops]



**DAILY CARE**



Warm water



Gentle soap



Microfiber Cloth



Use Trivets & Cutting Boards

**A FEW TIPS for your quartzite countertops!**

Because the bulletproof /stain proof stone is not invented yet, here are a few useful tricks!



**ORGANIC SOURCES**

[food colorant, spices, wine, mustard, coffee, etc.]

Spray the surface with Windex Original. Let it sit 5 minutes without letting it dry (continue to spray if needed). Wipe down, rinse and dry with a clean microfiber cloth.



**METALLIC SOURCES**

[scrapes made with belt buckle abrasion, residues left by pots/pans, etc.]

Cover the area with a paper towel, exceeding the zone about 1 inch all around. Pour CLR on the paper towel. Cover with plastic wrap **without** sealing the edges. Let sit 1 hour, rinse with hot water. Then, use a magic eraser soaked with CLR, scrub the area in circular motions with light pressure. Rinse with hot water, dry completely with clean microfiber cloth.



**RED WINE**

[residue often pinkish, a bit tacky]

Pour the product "Red Wine Stain Remover" on the area and follow the instructions on the package. Rinse and dry completely with a clean microfiber cloth. If the situation persists, repeat but with Peroxyde Vol. 40. Let sit 2 hours (or more). Rinse and dry completely with a clean microfiber cloth.



**OILS & FATS**

[residue that will darken the stone in certain areas or the entire surface]

Mix baking soda and water to create a paste. Spread on stain, about 1/4 inch thick. Cover with plastic wrap, and seal edges with green paint tape. Leave for 24 to 48 hours. Remove using microfiber cloth and warm water. If the situation is resolved, apply a sealer. If it persists, consult our experts.



**AVOID**

**SPONGES**

Abrasive products

Acids

Chemical products & bleach

Wax or any other polishing product

## ITARA (quartzite) | Brazil | Slab ≈ 116 x 68

This fascinating natural quartzite, also known under the name Verde Esmeralda, offers white and off-white contrasting veins on an emerald green background, reminiscent of dark stormy waters.

Resin and mesh are added to the stone, making it safer to handle. This comes with certain limitations in fabrication, but a carefully designed project will create an elegant result. Unlike marble, quartzite will not react to acids; therefore will not etch.

### Characteristic



### Variation



Layout strongly recommended

### Finish



### Resistance



### Thickness

1 1/4"

### Applications

indoor

outdoor



## Dare to do the lemon test



Cut two lemon wedges. Place one wedge on a quartzite sample, and one on a marble sample of your choice (e.g.: Bianco Carrara). Wait 5 to 10 minutes. Remove the lemon wedges and wipe the sample dry. Look at the marble under different angles. What do you see? Do you see the same on the quartzite? [What you see on marble is what is called etching!]



**ZERMATT (quartzite)** | Brazil | Slab ≈ 116 x 68

This natural quartzite offers soft veins and crisp tones of cool whites and greys. Resin and mesh are added to the stone, making it safer to handle. This comes with certain limitations in fabrication, but a carefully designed project will create an elegant result. Unlike marble, quartzite will not react to acids; therefore will not etch.

**Characteristic**



**Variation**



Layout strongly recommended

**Finish**



**Resistance**



**Thickness**

1 1/4"

**Applications**

indoor

outdoor



# microfissure and quartzites

You see them in these photos? These ancient hairline fractures that cover the surface, or the deeper ones that follow a vein, that look like a crack? In reality, these are cracks! See page 20 for more details!





# Understanding Soapstone

© Photo : Armoires Cordeau & AKB Design - Black Soapstone | Templated, fabricated & installed by Granit Design

## Soapstone : unmatched softness & timeless style

The history of this stone is rich and fascinating. Soapstone (also known as steatite) was first used by South American and Scandinavian tribes as a cooking surface over wood fires, as well as for the creation of everyday tools.

Its **zero porosity** and **high resistance to heat** made it an ideal material: naturally antibacterial, stain-resistant, and easy to clean, much like a Teflon pan.

Artisans also discovered another remarkable quality: **its soft, smooth feel** and the **ease with which it can be shaped and carved**. Thanks to this unique property, countless sculptures were created, capturing significant moments of each era. This practice crossed borders, notably reaching the Inuit, who still carve soapstone today to depict animals and iconic figures from their culture.

During the colonization of the Americas, settlers adopted soapstone for various uses: **cooking surfaces**, **heated bricks** to warm beds, and **fireplace surrounds**.

It wasn't until the late 1990's that soapstone's popularity as a **countertop material** truly surged, notably through influential shows such as Martha Stewart Living, which helped revive the Farmhouse Chic style.

## Why choose Soapstone

Today, its classic elegance, resistance to heat and acids, and versatility make it a sought-after choice for kitchens, sinks, pizza ovens, and much more.

## THINGS TO CONSIDER before choosing Soapstone



**Scratches are inevitable.** Its high magnesium and talc content make the stone prone to scratching. A zen approach is recommended—embrace its rustic charm.



**Regular maintenance is required.** Although non-porous (so it won't absorb stains), soapstone shows everything on the surface, even simple fingerprints. To reduce this effect, mineral oil or beeswax can be applied. This maintenance should be repeated a few times a year, depending on use and personal preference.

Although soapstone is more susceptible to scratching, it has the advantage of being restorable. Whether you're a DIY enthusiast or prefer to rely on our artisans, most marks can be removed using relatively simple methods. And if you choose to let them remain, they simply enhance the "Rustic Chic" character of your surface.

# for these oops moments! [on your soapstone countertops]

## DAILY CARE



Warm  
water



Gentle  
soap



Microfiber  
Cloth



Use Trivets &  
Cutting Boards

## A FEW TIPS for your soapstone countertops!

Because the bulletproof /stain proof stone is not invented yet, here are a few useful tricks!



### ORGANIC SOURCES

[food colorant, spices, wine, mustard, coffee, etc.]

With a gentle soap and warm water, scrub the surface with a new sponge until the soap suds. Rinse the sponge and wipe the surface. Repeat. End with a clean damp microfiber cloth, wipe to remove the soap completely. Repeat if needed.



### LIMESTONE

[residue that is rough to the touch, white, semi-opaque]

Apply in a circular motion Soft Scrub with bleach using a wet rag. Let it sit 5 to 10 minutes. Rinse thoroughly. Dry using a clean cotton cloth.



### OILS & FATS

[residue that will darken the stone in certain areas or the entire surface]

Spray the surface with Windex Original. Let it sit 5 minutes without letting it dry (continue to spray if needed). Wipe down, rinse and dry with a clean microfiber cloth.

If this method does not work, use the Organic Source Method.



### SCRATCHES\*

[scratches or scuffs that dig into the countertop]

**Superficial scratches:** Clean the countertop, apply mineral oil, rub vigorously with clean soft cloth. Repeat as needed.

**Deep scratches:** Use 200 grit sand paper in circular movement, cover a large area around the scuff, repeat with 400 then 800 and finish with a Scotch Brite pad. Clean and oil if desired.



### AVOID

Sealers

Polishing products

Objects that can scuff the surface

\* The restoration process for scratches can be exhaustive. If you do not feel comfortable doing it yourself, contact us to schedule a service call so that our experts can do it for you.

## SOAPSTONE | Brazil | Slab ≈ 116 x 68

Used for centuries in Brazil as cooking surface, Soapston has captured the world by its authentic beauty. Naturally non-porous, thus antibacterial and stain-resistant, it is also the natural stone that offers the highest heat resistance. Its soft honed finish can be left as is for a more rustic feel, or it can be oiled to enhance the stone's rich color contrasts. Featuring various shades of grey, each slab is unique. This stone is as practical as it is refined; ideal for households who enjoy the charm that comes with living materials that will evolve as years go by.

### Characteristic



### Variation



Layout strongly recommended

### Finish



### Resistance



### Thickness

1 1/4"

### Applications

indoor

outdoor



## You want the **wet look?**

Make sure to offer our mineral oil that:

- ✓ Enhances the stone's colors;
- ✓ Increases the contrast between the veins and the background;
- ✓ Dissimulates better finger marks and oily residues;
- ✓ Goes on easy with just a clean soft cloth, as often as you want;
- ✓ Will not cause any odour, and is 100% safe for direct contact with food.





# Understanding Marble

© Photo : Granite Design - island in Eureka marble & Wakanda quartzite.

## Marble: timeless elegance and functional ally in the kitchen.

Marble is a natural stone that has stood the test of time with unmatched elegance. Used since antiquity by architects, sculptors, and craftsmen, it remains today a symbol of refinement and good taste. Beyond its prestige and beauty, marble is also a functional material that, when used thoughtfully, can transform the at-home culinary experience.

Many people hesitate to introduce marble into their kitchens due to its reputation as a more delicate stone. Its porosity and sensitivity to staining are often cited as concerns. Yet these characteristics have never prevented its adoption by culinary professionals. For generations, bakers and pastry chefs have chosen marble as their preferred work surface. Why? Because marble is **naturally cool to the touch**, making it the ideal ally for rolling dough, working puff pastry, or tempering chocolate. Its **smooth**, pleasant surface makes handling ingredients easier and allows for **quick, effortless cleaning**. In addition, its heat resistance allows **hot baking sheets to be placed on it without concern**.

Thus, marble is not simply a noble and aesthetic stone; it also stands as a true culinary tool, appreciated by both professional chefs and passionate home cooks. It is a choice that blends beauty and practicality, an investment that adds both visual value and everyday enjoyment.

### Marble or dolomitic marble: what's the difference?

Dolomitic marble contains multiple intrusions of various minerals, which results in richer and more varied coloration. Most of these minerals are not calcites. As a result, dolomitic marbles react less to acids than classic marbles.

### Why choose marble

To enjoy a stone that transcends trends and remains a timeless symbol of luxury and authenticity. Fully appreciating marble means embracing its unique personality—its subtleties, markings, and variations. In return, it offers unmatched charm and functionality. More than a countertop, **marble becomes a statement piece, a focal point that elevates your kitchen and enhances your culinary moments.**

### THINGS TO CONSIDER before choosing marble



**Etching is inevitable.** This phenomenon occurs when marble comes into contact with acidic substances such as coffee, wine, lemon juice, or even certain household cleaners. It appears as marks that are visible under light or noticeable to the touch. This is not a flaw, but an inherent characteristic of marble. To minimize its appearance, a honed (matte) finish is recommended, as it better conceals etching while preserving the stone's softness and natural character.



**More frequent maintenance.** While marble is more porous than other stones, such as granite or quartzite, solutions do exist to reduce its sensitivity. Our exclusive GDGuard™ treatment acts as a protective barrier, reducing the stone's porosity and making daily maintenance easier. Although the standard warranty typically applied to granite and quartzite is not offered for marble, this treatment is a valuable asset in preserving marble's beauty over time.

## Did you know?

# Understanding etching



Photo above, left : Eureka marble, etching less visible.  
Photo right : Eureka marble, etching visible

**Etching** (or acid dulling) is a natural phenomenon that distinguishes marble from other stones. Unlike a stain, which penetrates and colors the stone, etching results from a **chemical reaction between acidic substances and calcium carbonate**, the main component of marble. When acidic foods or liquids – such as wine, coffee, vinegar, citrus fruits, or even certain sauces – come into contact with the surface, they cause a micro-dissolution of the stone's top layer.

The result is a subtle mark that can be observed in two ways:

**Visually:** as a matte haze, halo, or an area that appears duller than the rest of the surface.

**To the touch:** as a slight roughness or loss of smoothness.

These marks do not affect the structural integrity of marble; they are purely aesthetic. Etching should not be seen as a weakness, but rather as part of marble's authenticity. Each small mark is proof of a living kitchen—used and loved. For enthusiasts, this is precisely what makes marble so unique: a noble material that evolves with its environment and develops a natural patina over time.

## Can etching be avoided?

It is important to understand that etching is inevitable on marble, regardless of the care taken or treatments applied. However, there are ways to make it less noticeable and easier to accept:

### Choose the right finish

**Polished** (glossy) finish highlights the richness and contrast of the veining, but makes etching more visible, as dull areas stand out against the surrounding shine.

**Honed** (matte) or antique finish is recommended. It better conceals marks and offers a soft, silky texture that complements the stone's natural character.

### Adopt proper maintenance habits

- ✓ Wipe up acidic spills promptly
- ✓ Use cutting boards and coasters to reduce direct contact
- ✓ Use cleaners specifically designed for marble, free of acids and abrasive agents

The GDGuard™ treatment helps reduce the stone's porosity and provides better protection against staining liquids (e.g., red wine), but it does not prevent etching.

Professional repolishing can correct certain situations, but the process is costly and demanding.

# for these **oops moments!** [on your **marble** countertops]

## DAILY CARE



Warm  
water



Gentle  
soap



Microfiber  
Cloth



Use Trivets &  
Cutting Boards

## A FEW TIPS for your marble countertops!

Because the bulletproof /stain proof stone is not invented yet, here are a few useful tricks!



### ORGANIC SOURCES

[food colorant, spices, wine, mustard, coffee, etc.]



### RED WINE

[residue often pinkish, a bit tacky]



### OILS & FATS

[residue that will darken the stone in certain areas or the entire surface]



### AVOID

#### SPONGES

Abrasive products

Acids

Chemical products & bleach

Wax or any other polishing product

Any citrus-based or vinegar-based product (natural cleaning products, etc.)

## DEEP CLEANING METHOD

Mix baking soda and water to create a paste.

Spread on stain, about 1/4 inch thick.

Cover with plastic wrap, and seal edges with green paint tape.

Leave for 24 to 48 hours. If the situation is resolved, apply a sealer.

If it persists, consult our experts.

**FANTASY BROWN (dolomite)** | India | Slab ≈ 110 x 69

Neither entirely marble nor entirely quartzite, Fantasy Brown is a unique natural stone with undeniable charm. Its flowing waves of soft gray, sandy brown, and creamy white create a calming, organic visual effect, perfect for warm and elegant interiors. Heat resistant and denser than traditional marble, it is well suited for both kitchens and bathrooms. Each slab tells a story of movement and texture, making it ideal for projects with natural, timeless refinement. Less sensitive to acids than traditional marble, an antique finish helps minimize the appearance of etching.

**Characteristic**



Treatment not warranted

**Variation**



Layout strongly recommended

**Finish**



**Resistance**



**Thickness**

1 1/4"

**Applications**

indoor

outdoor



© Photo : Ateliers Jacob



what are  
**dolomites**

These are natural marbles featuring a **higher concentration of intrusions** and minerals **other than calcium**. Thanks to this composition, they are less sensitive to acids than traditional Italian marbles. The etching phenomenon is **still present** (although reduced with honed or antique finishes) and should therefore be taken into consideration when selecting these stones.

# roundness and natural stones

Rounded shapes and edges are more popular than ever!

Most natural stones will welcome rounded edges without much concerns.

Some natural stones, most particularly quartzites and dolomites, which are more fragile to fabricate due to the higher presence of microfissures, can be worked manually, but its unique nature may require more time, and material when the unexpected occurs.

The process may also reopen old microfissures during the process. This will not alter the stone's beauty; however, they will be visible and will be easy to feel.

Our expert advice; be patient and have a **plan B**, just in case the stone would be more challenging.

Photo : Marau Quartzite, with a combination of small ogee & full bullnose edge profiles.



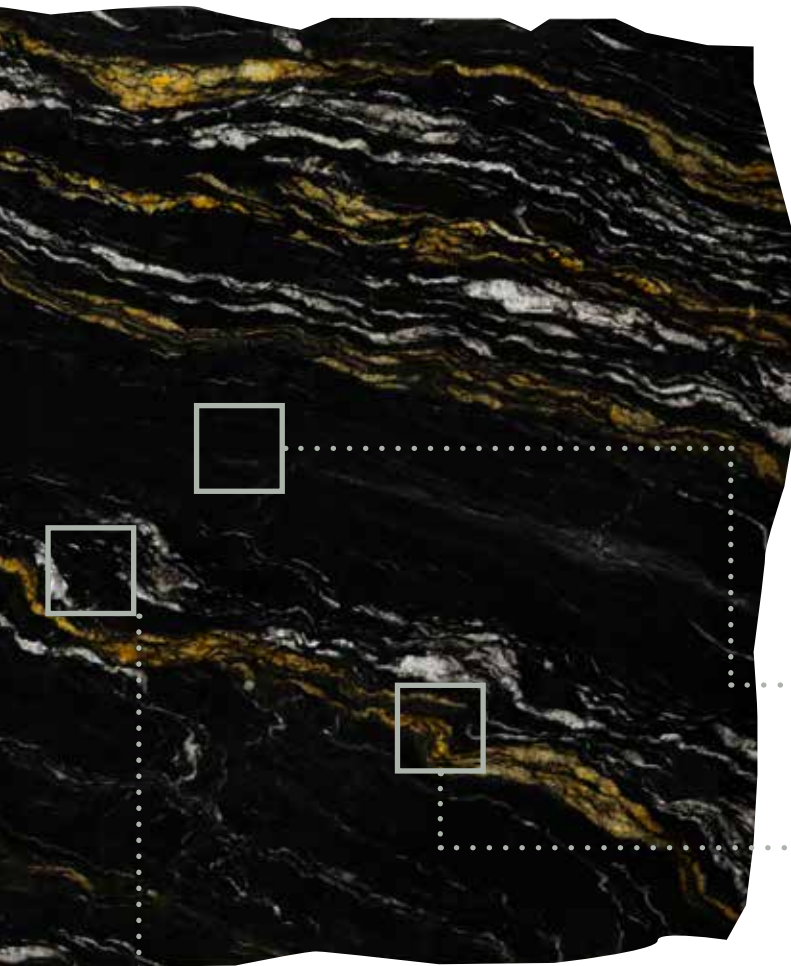

Slab photo : Orinoco Granite

# Understanding natural variation

Each natural stone is a unique work of art. No two slabs are identical: veining, color nuances, and mineral composition vary from one block to another. This is what gives natural stone its beauty and authenticity.

If your client prefers a more uniform appearance, guide them towards a low-variation stone or towards engineered surfaces (mineral or ultra-compact).

## ABOUT SAMPLES

A sample shows only a very small portion of a slab. The greater the natural variation in the stone, the more samples will differ from one another.



# Understanding the natural variation chart

	SYMBOL	LAYOUT	COMMENT	
	①	Low variation	Not offered	A stone perfectly suited for large-scale projects.
	②	Medium variation	Available	Some variation, yet consistent enough for extensive projects.
	③	High variation	Strongly recommended	Significant variation from one slab to another. It may be difficult to source a similar slab after several months, so ALL components of the project should be planned at the same time (countertops, backsplash, window sills, etc.).
	④ CAREFUL	Handle with care	Strongly recommended	Considered an exotic stone (more fragile). It will feature mesh on the back, and sometimes fiberglass reinforcement along the slab edges. Thinning, more intricate edge profiles, and other fabrication limitations may apply depending on the project.

## 2026 Natural Stone Collection



ALPINE VALLEY **P**

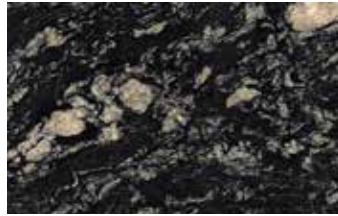

AMELIA RIDGE **P**



AZUL PLATINO **P**



BIANCO ANTICO **P**



BLACK MIST **H**



BLACK PEARL **P**



BLACK SOAPSTONE **H**



BLUE DUNES **C**

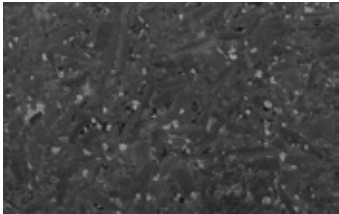

CAMBRIAN BLACK **A P**



FANTASY BROWN **B P**



GREY MIST **P**



ITARA **P**



ORINOCO **P**



SAINT-HENRY **A**



STEEL GREY **P**



UBATUBA **P**



VALLE NEVADO **P**



VIA LATTEA **P**



WATERFALL **P**



ZERMATT **P**

**FINISHES:** Antique **A** Brushed **B** Caresse **C** Honed **H** Polished **P** **SLAB DIMENSIONS:** will vary depending on quarried blocks size.  
**COLOR:** each natural stone slab is unique. Samples may not represent the stone selected for your project. We recommend layouts for medium to high variation stones.



## when should you offer the vein flow

When special attention must be given to a seam or joint to enhance vein continuity and flow. For example, when a project includes an oversized island with waterfall sides.

# MINERAL SURFACES





# Our partners

at the forefront of innovation



## HYBRIQ TECHNOLOGY®

**HybriQ** is Silestone® by COSENTINO's pioneering technology: a unique **hybrid formulation combining premium minerals, quartz, and recycled glass**. The result? Beautiful, durable surfaces are produced through a process powered 100% by renewable energy and reused water.

**HybriQ+** goes even further. It incorporates **at least 20% recycled materials** and strengthens Cosentino's commitment to the circular economy. This new generation of surfaces sets a new benchmark in design, innovation, and sustainability.

- A MINIMUM OF **20%** recycled materials
- 99%** reused water and circular economy
- 100%** use of renewable energy sources



# Why CHOOSE Silestone®

Silestone® is comprised of superior quality minerals, designed to offer authentic colors and textures for kitchen and vanity surfaces. Its unique properties ensure its durability to the elements for an inspiring beauty that withstands the test of time.



Resistant to daily stains



More resistant to scratches vs. certain natural stones



Non-porous material, easy to care for and antimicrobial



Material that requires no additional sealer after installation



Seams are water-resistant, unlike laminate countertops



Fabricated in Spain with innovative technologies and the industry's highest quality standards

Silestone® is covered by a 25-year limited warranty. Make sure to consult their website: <https://www.cosentino.com/en-ca/silestone/warranty/>



# for these **oops moments!** [on your **quartz/mineral surface** countertop]

## DAILY CARE



Warm water



Gentle soap



Microfiber Cloth



Use Trivets & Cutting Boards

## A FEW TIPS for your mineral surface countertops!

Because the bulletproof /stain proof stone is not invented yet, here are a few useful tricks!



### ORGANIC SOURCES

[food colorant, spices, wine, mustard, coffee, etc.]

Spray the surface with Windex Original. Let it sit 5 minutes without letting it dry (continue to spray if needed). Wipe down, rinse and dry with a clean microfiber cloth.



### METALLIC SOURCES

[scrapes made with belt buckle abrasion, residues left by pots/pans, etc.]

Cover the area with a paper towel, exceeding the zone about 1 inch all around. Pour CLR on the paper towel. Cover with plastic wrap **without** sealing the edges. Let sit 1 hour, rinse with hot water. Then, use a magic eraser soaked with CLR, scrub the area in circular motions with light pressure. Rinse with hot water, dry completely with clean microfiber cloth.



### LIMESTONE

[residue that is rough to the touch, white, semi opaque]

Remove the residue using a new flat blade. Pour CLR on the area (protecting surrounding walls, faucet, etc.). Let it sit about 2 hours. Rinse thoroughly and dry completely using clean microfiber cloth. Repeat if needed.



### OILS & FATS

[residue that will darken the stone in certain areas or the entire surface]

Apply, using a new wet sponge, Soft Scrub with bleach, **WITHOUT SCRUBBING**. Let sit up to 20 minutes without letting it dry (keep moist with the sponge or by spraying the surface with water). Gently remove the product with the wet sponge until the residue/deposit disappears. Rinse and dry completely with clean soft cloth. Repeat if needed.



### AVOID

- Metal scrubbing pads
- Degreasing agents
- Exposure to chlorine-based products
- Products with hydrofluoric acid
- Oven cleaner
- Nail polish remover
- Products with pH levels superior to 10.
- Exposure to heat & UV rays

# ENGINEERED

*mineral surfaces*  
are and elegant and timeless material

that resists food & beverage stains and offers good resistance levels to scratches [still, we recommend the use of cutting boards!]. More sensitive to heat, the use of trivets is strongly encouraged to avoid thermal shocks & discoloration.



## RECEIVING

Natural minerals are received in powdered form, and combined using exclusive Silestone® Cosentino recipes.



## COMBINING

These powders are combined with resins and recycled materials to create a homogeneous mixture.



## COLORING

Pigments are added and veins are created to obtain the desired stones.



## COMPACTING

The moulded mixture undergoes intense vibration to remove air and compress the mixture to create a dense slab.



## COOKING

Slabs are cooked to harden the resin and then cooled to create a durable material.



## FINISHING

Slabs receive the desired finish, are inspected and shipped worldwide.

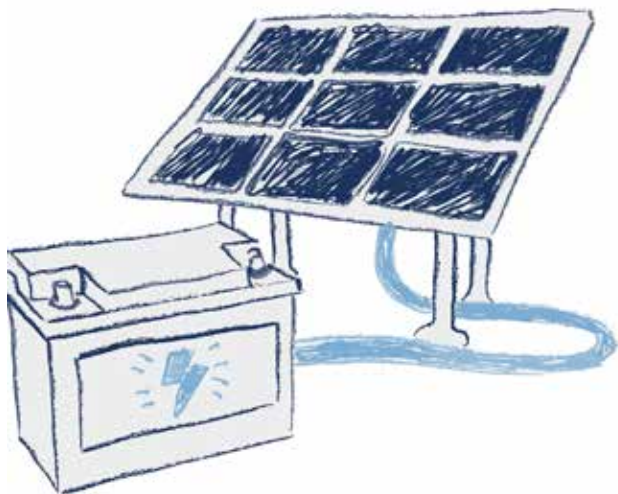

Cosentino is proud to invest in tomorrow's clean future, with a solar park of over 38 000 panels in operation.









**BLANC ELYSEE** (  mineral surface ) | Spain | Slab : 126 x 62

A delicate lattice of golden, grey, and copper veins along with graphic depth runs through a bright cream background that updates the timeless elegance of classic Parisian palaces.

**HYBRIQ**  
TECHNOLOGY



<b>Variation</b>	 Layout strongly recommended
<b>Finish</b>	
<b>Resistance</b>	  
<b>Thickness</b>	1 1/4"
<b>Applications</b>	<b>indoor</b> <span style="background-color: #ccc; padding: 2px;">outdoor</span>
<b>Particularity</b>	 Always use a trivet to avoid thermal shocks & discoloration.





**CALACATTA GOLD** (  mineral surface)  
Spain | Slab : 126 x 62

A color made up of a white background through which elegant, wide grey highlights are interspersed with unexpected golden glints. Eternal Calacatta Gold, with its eternal, distinguished appearance, pays homage to a marble which has been held in high esteem since ancient times.



**Variation**

**3**

Layout strongly recommended

**Finish**

**P**

**S**

**Resistance**



**Thickness**

1 1/4"

**Applications**

**indoor**

**outdoor**

**Particularity**



Always use a trivet to avoid thermal shocks & discoloration.



*Beautiful,*

these stones are long-time favourites. Paired with modern hues, they create timeless design concepts.

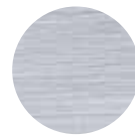

Stainless



Brass



Raven





**BRONZE RIVERS** (  mineral surface) | Spain | Slab : 126 x 62

Bronze Rivers reinterprets the classic patterns of white marble with a suggestive and abundant veining of varying intensities. The balanced blend of grey and gold tones imbues an elegant, warm white background with timelessness. A versatile and sophisticated option that infuses style and warmth to any space.

**HYBRIQ**  
TECHNOLOGY



**Variation**

**3**

Layout strongly recommended

**Finish**

**P**

**Resistance**



**Thickness**

1 1/4"

**Applications**

**indoor**

outdoor

**Particularity**



Always use a trivet to avoid thermal shocks & discoloration.





**STATUARIO** (  mineral surface)  
Spain | Slab : 126 x 62

Inspired by the classic Italian Carrara marble, Eternal Statuario has a white surface with very soft, sparkling highlights in a shade of grey. Color and harmony are fused in a background that stands out for its remarkable sense of depth.



**Variation**



Layout available

**Finish**



**Resistance**



**Thickness**

1 1/4"

**Applications**

**indoor**

outdoor



**Particularity**



Always use a trivet to avoid thermal shocks & discoloration.



*Beautiful,*

these stones are long-time favourites. Paired with modern hues, they create timeless design concepts.

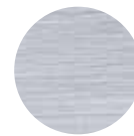

Stainless

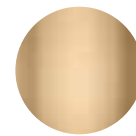

Brass



Raven





**PERSIAN WHITE** (  mineral surface) | Spain | Slab : 126 x 62

Inspired by the simplicity and delicacy of its namesake marble, Persian White features a blend of fine, even veins in creamy tones and an organic vein structure in harmonious shades. This versatile white adds a touch of warmth and luminosity, making it ideal for any space.

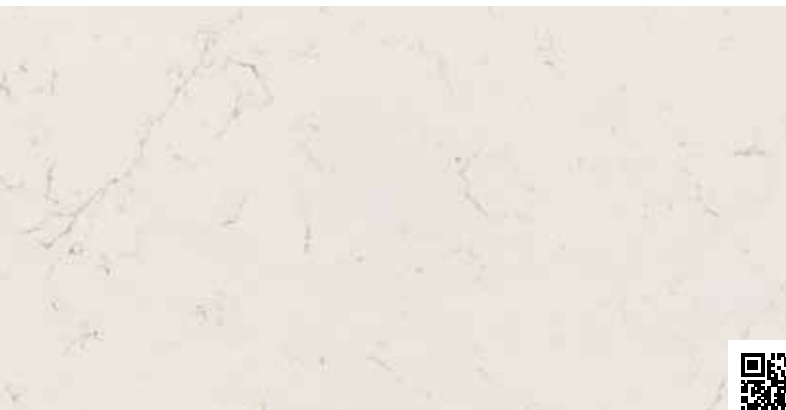

**Variation**



Layout available

**Finish**



**Resistance**



**Thickness**

1 1/4"

**Applications**

**indoor**

outdoor

**Particularity**



Always use a trivet to avoid thermal shocks & discoloration.





**ETHEREAL GLOW** (  surface minérale)  
Spain | Slab : 126 x 62

The veins, in elegant shades of gold and grey, blend into a nuanced white background, crossing the board and distributing the color in every corner, adding value to the design.



**Variation**



Layout strongly recommended

**Finish**



**Resistance**



**Thickness**

1 1/4"

**Applications**

**indoor**

outdoor

**Particularity**



Always use a trivet to avoid thermal shocks & discoloration.



*Beautiful,*

these stones are long-time favourites. Paired with modern hues, they create timeless design concepts.

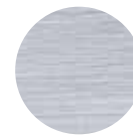

Stainless

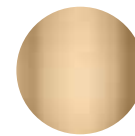

Brass



Raven





**SIBERIAN** (  mineral surface ) | Spain | Slab : 126 x 62

This color reinterprets the classic Calacatta marble, bringing subtlety and elegance through a pattern of warm veins intertwined with grey veins.



**Variation**



Layout strongly recommended

**Finish**



**Resistance**



**Thickness**

1 1/4"

**Applications**

**indoor**

outdoor

**Particularity**



Always use a trivet to avoid thermal shocks & discoloration.





**HELIX** (  mineral surface)  
Spain | Slab : 126 x 62

Its intensity and design will bring to any environment all the strength and liveliness to become a magical and welcoming place.



**Variation**



Layout available

**Finish**



**Resistance**



**Thickness**

1 1/4"

**Applications**

**indoor**

**outdoor**

**Particularity**



Always use a trivet to avoid thermal shocks & discoloration.



*Beautiful,*

these stones feature timeless, subtle designs. Paired with rich tones, they bring elegance to any space.

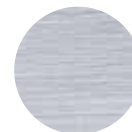

Stainless

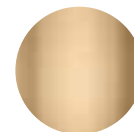

Brass



Raven



## 2026 Quartz & Mineral Surface Collection



**BLANC ELYSEE** **P**  
126 x 62



**BLANCO MAPLE** **P**  
119 x 53 & 126 x 62



**BRONZE RIVER** **P**  
126 x 62



**CALACATTA GOLD** **P S**  
126 x 62



**DESERT SILVER** **P**  
126 x 62



**ETHEREAL GLOW** **P**  
126 x 62



**HALCYON** **P**  
126 x 62



**HELIX** **P**  
126 x 62



**LINEN CREAM** **P**  
126 x 62



**MIAMI VENA** **P**  
126 x 62



**MIAMI WHITE** **P**  
119 x 53 & 126 x 62



**MOTION GREY** **P**  
126 x 62



**PERSIAN WHITE** **P**  
126 x 62



**SEAPORT** **S**  
126 x 62



**SIBERIAN** **P**  
126 x 62

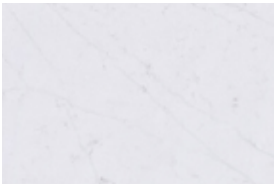

**STATUARIO** **P S**  
126 x 62



**STELLAR BLANCO** **P**  
126 x 62



**VERSAILLE IVORY** **P**  
126 x 62



**BERWYN** **P**  
129 x 62



**BRIT. GOLD WARM** **P**  
129 x 63



**CALACATTA VENATO** **P**  
128 x 63

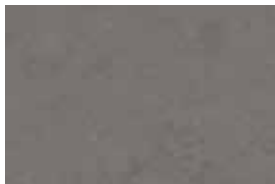

**CHARLESTOWN** **P**  
129 x 62



**ETUDE** **P**  
129 x 62



**EVEREST** **P**  
128 x 61

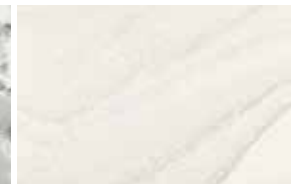

**EVERLEIGH** **P**  
129 x 63

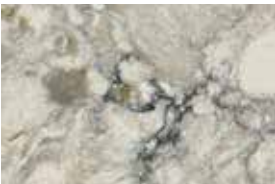

**INTERMEZZO** **P**  
129 x 62



**MACAUBAS BIANCO** **P**  
124 x 61 & 136 x 77



**MATTERHORN** **P**  
129 x 63



**MONTAUK** **P**  
128 x 63



**TRAVELLA** **P**  
130 x 63

**FINISH** Polished **P** Suede **S**

It is possible that colors be available in a Suede Finish, however they may be special order. Validate pricing and finish availability.

### WHEN SHOULD YOU OFFER THE VEIN FLOW

When special attention must be given to a seam or joint to enhance vein continuity and flow. E.g.: when a project includes an oversized island with waterfall sides.

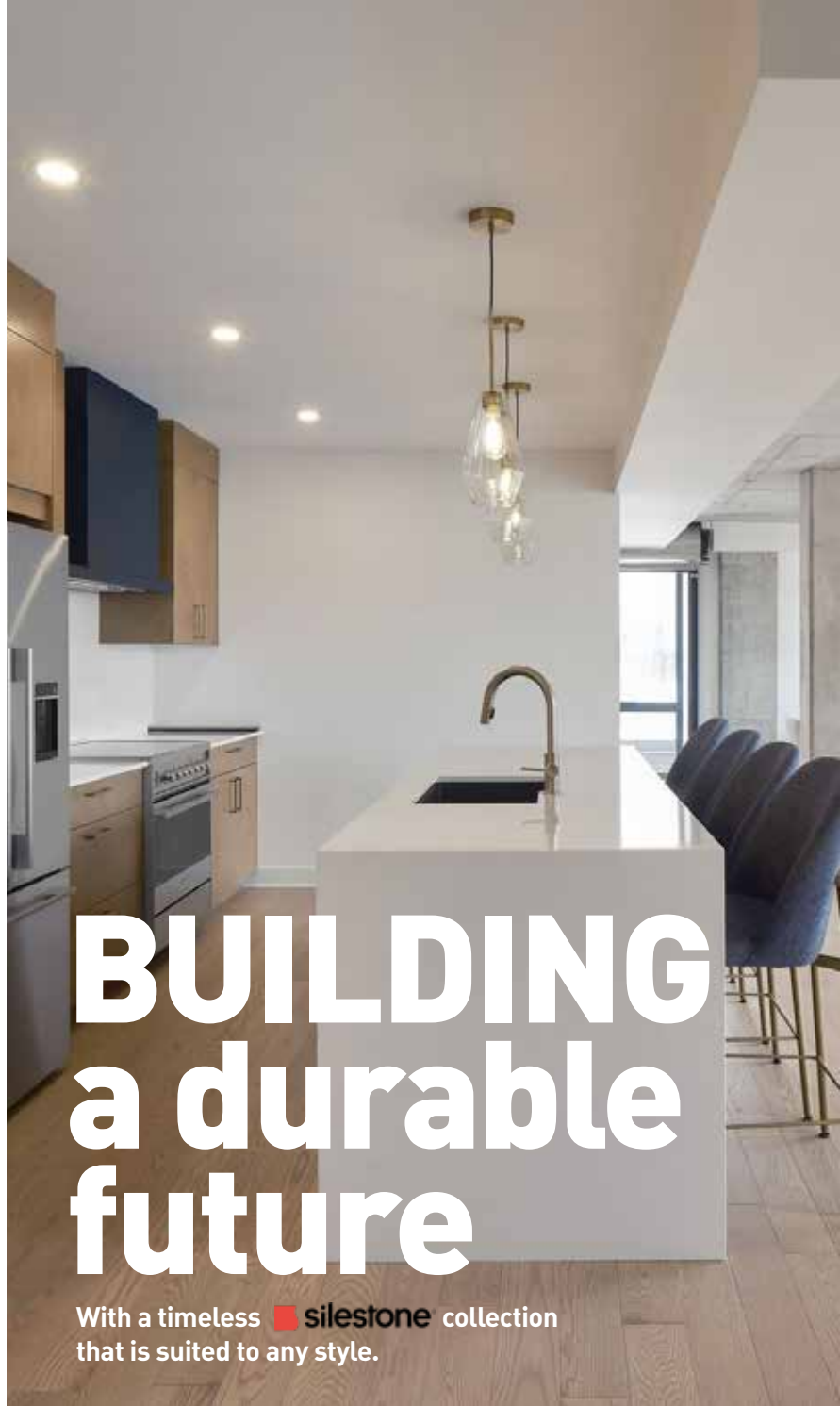

# BUILDING a durable future

With a timeless  **silestone** collection  
that is suited to any style.

**Our commercial collection** offers quality products that can be used for several types of large-scale indoor applications.

The material's stain, scratch and acid resistance make these surfaces easy to care for. The timeless designs are constant from one slab to another, and our efficient supply chain ensures quantities are available for large-scale projects.



# the commercial collection **Ideal for any builder**

## Condo | Multi-Unit | Commercial | Institutional

**GRANITEDESIGN** is proud of working with Cosentino, world leaders in their field, to ensure a constant supply of these stones at a competitive price, allowing construction industry professionals the possibility to offer customers a high quality, ecofriendly surface.



### SELECTION

quality material with low color variation between slabs



### SUPPLY

in sufficient quantities to ensure efficient inventory management with large-scale projects



### VALUE ENGINEERING

by our team to optimize and offer upgrades that will save you time & effort



### SCHEDULED DELIVERIES

to adapt ourselves to the rhythm of a job site

Choosing Silestone®, it's choosing performance, design, and environmental commitment for your commercial projects.

Silestone® contributes to obtaining LEED points in several categories.

HYBRIQ EPD®



MIAMI VENA

HALCYON

MOTION GREY

BLANCO MAPLE

MIAMI WHITE



# ULTRA-COMPACT

## SURFACES

# ULTRA-COMPACT

surfaces

is a unique material, resembling porcelain,

that distinguishes itself by its exceptional resistance to UV rays, scratches, stains, abrasion and high heat. These performance levels are made possible by a unique composition without any resin and by the incredible pressure that is applied to each slab - equivalent to 25 000 tonnes, which is 2 1/2 Eiffel towers !

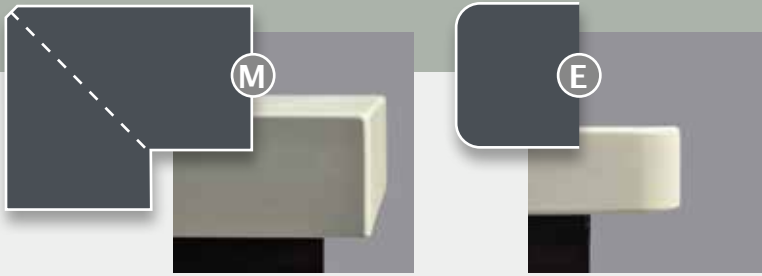

## The edge & Dekton®

The Eased Edge (E) and Miter Edge (M) are the two possibilities.

**With the Eased edge, the material visible on the edge will be a solid color, and will have a honed finish.**

## concretely, WHAT DOES THAT MEAN?

### EDGE PROFILES

[ AND PATTERN / FINISH CONTINUITY ]

With Dekton®, because the pattern is printed on the surface of a neutral-colored bisque of high-quality ingredients, the vein continuity throughout the thickness is not often present (only a few Dekton® colors offer this possibility). By choosing the Eased edge, the **edge will be honed and of a solid color.**

To avoid this situation, choose the Miter edge border with a 45-degree assembly, which will enable veins and finish continuity, and you can choose the thickness you want!



**Dekton® Arga - 2cm  
Eased Edge**  
Beige visible bisque

© Photo : Cosentino



**Dekton® Arga  
Miter Edge**  
Continuous effect

© Photo: Armoires Cordeau  
Template, fabrication & installation : Granite Design

# Why CHOOSE Dekton®

Thanks to its proprietary blend of superior quality minerals and technologically advanced process, Dekton® is a material that offers incredible performances.



Resists high temperatures without burning or cracking



Whereas other surfaces are stain resistant, Dekton® is completely stain proof, antibacterial, and will resist chemical and corrosive products



Non-porous material, easy to maintain and antimicrobial



Dekton® matte finish offers the highest resistance to scratches on the market



Highly resistant to UV rays, Dekton® will not discolor, making it ideal for both indoor and outdoor applications



Seams are water-resistant, unlike laminate surfaces



Fabricated in Spain with innovative technologies and the industry's highest quality standards

Dekton® is covered by a 25-yr limited warranty. Make sure to consult their website at: <https://www.cosentino.com/en-ca/dekton/dekton-25-year-warranty-cosentino/>



# for these oops moments! [on your **ultra-compact** countertop]

## DAILY CARE



Warm  
water



Gentle  
soap



Microfiber  
Cloth

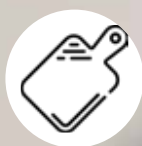

Use Trivets &  
Cutting Boards



### A FEW TIPS for your ultra-compact surface countertops!

Because the bulletproof /stain proof stone is not invented yet, here are a few useful tricks!



#### ORGANIC SOURCES

[food colorant, spices, wine, mustard, coffee, etc.]

Spray the surface with Vim Actifizz (or other product with oxidant properties)

Let sit up to 5 minutes, rinse then dry with clean soft cloth.



#### METALLIC SOURCES

[scrapes made with belt buckle abrasion, residues left by pots/pans, etc.]

Cover the area with a paper towel, exceeding the zone about 1 inch all around. Pour CLR on the paper towel. Cover with plastic wrap **without** sealing the edges. Let sit 1 hour, rinse with hot water. Then, use a magic eraser soaked with CLR, scrub the area in circular motions with light pressure. Rinse with hot water, dry completely with clean microfiber cloth.



#### LIMESTONE

[residue that is rough to the touch, white, semi-opaque]

Remove the residue using a new flat blade. Pour CLR on the area (protecting surrounding walls, faucet, etc.). Let it sit about 2 hours. Rinse thoroughly and dry completely using clean microfiber cloth. Repeat if needed.



#### OILS & FATS

[residue that will darken the stone in certain areas or the entire surface]

Clean using an alkaline detergent or degreaser.



#### AVOID

- Metal scrubbing pads
- Sponges (to avoid bacteria accumulation)
- Direct contact with fire
- Shocks on more sensitive areas (sink surround, edge profile)

the process

# BEHIND PARTICLE SINTERING TECHNOLOGY



## RECEIVING

Natural materials in powder format are received and dispatched as per exclusive Dekton® by Cosentino recipes.



## COMBINING

These powders are combined to create a homogeneous mixture.



## COLORING

The mixture is colored with natural pigments to create a more aesthetic look.



## SINTERING

The mix is heated at 1200°C and compacted under a hydraulic press, simulating millions of years of heat and pressure within a few hours.



## COMPRESSING

Mineral particles are fused together, creating an ultra-dense structure, void of any pores.



## FINISHING

Slabs are decorated and the desired finish is applied, then each slab undergoes quality control before being shipped to stone fabricators worldwide.



Each Dekton® slab is subject to a 25 000-ton compression, That's 2 and a half Eiffel towers!



**KELYA** (  Ultra-Compact ) | Spain | Slab : 129 x 63

With a touch of particularity, this tone is inspired by dark marbles with light streaks for the most special environments.

**Characteristic**



**Variation**



Layout strongly recommended

**Finish**



**Resistance**



**Thickness**

20mm

12mm

8mm

**Applications**

indoor

outdoor

**Available Edges**



© Photo : Template, fabrication & installation, Granite Design



## finishes **HONED V. VELVET**

The honed finish offers a smooth texture that does not reflect light for a natural, more subtle appearance, whereas the velvet finish will feature a very slight roughness that brings warmth, visual appeal and remains soft to the touch, a closer rendering to natural stone's organic texture.



© Photo: Cosentino

**REM** (  Ultra-Compact ) | Espagne |  
Tranche : 126 x 56 - 130 x 63

Rem is inspired by one of the most elegant white marbles on the market: its intricate design, with brown and grey veining and hints of gold, reflects the traditional and almost linear structure of Calacatta Lincoln itself. One of the greatest technological innovations is the synchronicity achieved between veining and grain. We value Rem for its fine veining under a subtle grain, which offers the ultimate in natural sensitivity.

**Characteristic**



**Variation**



Layout strongly recommended

**Finish**



**Resistance**



**Thickness**

20mm

12mm

8mm

**Applications**

indoor

outdoor

**Available Edges**



© Photo: RUBIC  
Measure, fabrication & installation : Granite Design



Beautiful,

these stones are timeless classics. Paired with warm and cozy hues, they can adapt to a wide variety of styles.



Stainless



Brass



Raven



© Photo: RUBIC  
Measure, fabrication & installation : Granite Design

Made-to-Measure by professionals



© Photo : Template, fabrication & installation, Granite Design



**TRANCE** (  Ultra-Compact ) | Spain | Slab : 129 x 63

Fluid color with a bluish veil. The background reveals a combination of cream and gray colors, a mix of tones that blend between white palettes. Fine streaks move between oxides and fade to reddish gold.

**Characteristic**



**Variation**



Layout strongly recommended

**Finish**



**Resistance**



**Thickness**

20mm    12mm    8mm

**Applications**

indoor

outdoor

**Available Edges**



*Beautiful,*

these nature-inspired stones can be paired with warm color schemes; creating rich, cozy spaces.

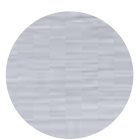

Stainless



Brass



Raven





© Photo : Cosentino

**LAURENT** ( Ultra-Compact ) | Spain | Slab : 122 x 54 - 129 x 63







Inspired by the natural stone Port Laurent, the striking colorway features a dramatic dark brown background crisscrossed with veins of gold.

Its vein texture is more pronounced compared to other veined Dekton®. This can impact seams and junctions, which will be more visible and easy to feel.

**Characteristic** 



**Variation**  Layout strongly recommended

**Finish** 

**Resistance**      

**Thickness** 20mm 12mm 8mm

**Applications** **indoor** **outdoor**

**Available Edges**  



© Photo : Cosentino

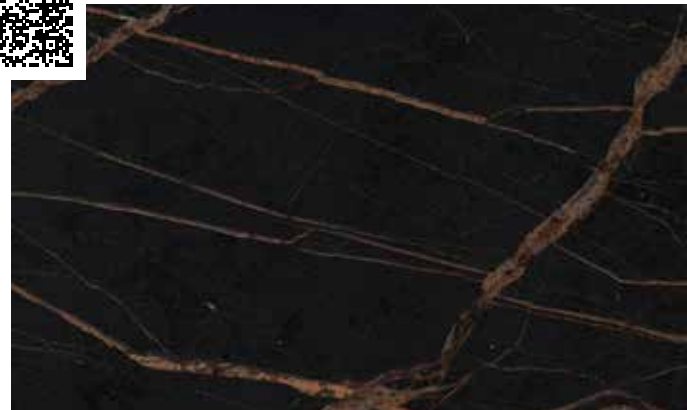

© Photo : Cosentino

## adding texture

Some Dekton® colors, the most popular being the **Laurent**, feature a more pronounced texture. This is added during the sintering process to recreate natural stone's organic feel more accurately.

This texture can recreate small pits, or unevenness in the slab, or can follow a vein, all of which may result in slight variances in height at the seam and/or junctions, which will make them more visible and easier to feel.



© Photo : template, fabrication & installation, Granite Design

**ARGA** (  Ultra-Compact ) | Spain | Slab : 129 x 63

Inspired by the quartzite of the Taj Mahal, Arga combines the luxury of natural stone with the properties of Dekton®. Its smooth cream background, with subtle brown-gold veins, intensifies its dramatic structure. A hyperrealist graphic, with a dazzling sheen, gives depth and richness to this material.

**Characteristic**



**Variation**



Layout strongly recommended

**Finish**



**Resistance**



**Thickness**

20mm

12mm

8mm

**Applications**

indoor

outdoor

**Available Edges**



*made-to-measure*  
**in Dekton®**

Thanks to our technologically advanced equipment, **GRANITEDESIGN** can fabricate sinks, fireplace facades, hoods, Spa inspired showers and much more.

Our experts can also guide you towards the right Dekton® thickness to use depending on your project's specifications.



© Photo : template, fabrication & installation by Granite Design

**MARINA** (  Ultra-Compact ) | Spain | Slab : 122 x 54 - 129 x 63

Marina is inspired by the whimsical salt patterns that low tide leaves on the sand and rocks. These delicate white ridges are materialized in an asymmetrical pattern of gray veins on a white base that reinterprets the classic elegance of Carrara marble. Its velvet finish adds softness and creates a more natural feel.

**Characteristic**



**Variation**



Layout strongly recommended

**Finish**



**Resistance**

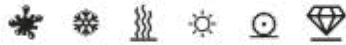

**Thickness**

20mm    12mm    8mm

**Applications**



**Available Edges**



© Photo : Cosentino



© Photo : Cosentino

*Beautiful,*

these nature-inspired stones in crisp, fresh tones are bright and airy. You can almost feel a coastal breeze.

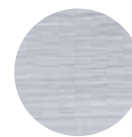

Stainless

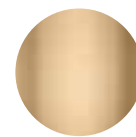

Brass



Raven









© Photo : Armoires Cordeau  
Measure, fabrication and installation: Granite Design



**SIRIUS** (  Ultra-Compact ) | Spain | Slab : 124 x 56

This black with textured visual sensation and greenish touches will bring realism and strength to the environment.

Since the end of 2025, the formula used for this color has improved; making it even richer & bolder than before.

<b>Characteristic</b>	
<b>Variation</b>	 Layout not recommended
<b>Finish</b>	
<b>Resistance</b>	
<b>Thickness</b>	20mm    12mm    8mm
<b>Applications</b>	<b>indoor</b> <b>outdoor</b>
<b>Available Edges</b>	

# changing the recipe!

The proprietary blends used for both Sirius and Domoos have been modified near the end of 2025 to offer a more mysterious, darker, blacker coloration than ever before.

Check your samples, make sure that you have the **Sirius25** and **Domoos25** to show customers so that expectations are properly set!



© Photo : Armoires Cordeau  
Measure, fabrication and installation: Granite Design

**NATURA** (  Ultra-Compact ) | Spain | Tranche : 130 x 63

Replicating the quintessential style of marble with soft grey veining accentuating the classic white surface, it also boasts a lustrous polished finish. With all the benefits of Dekton's technical characteristics, the striking colour's reflective nature is due to the nano-technological treatment and mechanical polishing process it undergoes, resulting in a crystal-like shine.

**Characteristic**



**Variation**



Layout strongly recommended

**Finish**



**Resistance**



**Thickness**

20mm    12mm    8mm

**Applications**



**Available Edges**



© Photo : template, fabrication & installation by Granite Design



*Beautiful,*

these nature-inspired stones can be paired with warm color schemes; creating rich, cozy spaces.

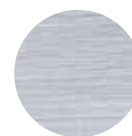

Stainless

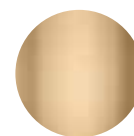

Brass



Raven



© Photo : Cosentino



© Photo : Cosentino



**MORPHEUS** ( Ultra-Compact ) | Spain | Slab : 122 x 54 - 129 x 63

Dekton® Morpheus, with a white base, presents different shades, reflections and flashes of color in the form of veining. It has a velvet finish that softens its tonality.

<b>Characteristic</b>	
<b>Variation</b>	<b>3</b> Layout strongly recommended
<b>Finish</b>	<b>V</b>
<b>Resistance</b>	
<b>Thickness</b>	20mm    12mm    8mm
<b>Applications</b>	<b>indoor</b> <b>outdoor</b>
<b>Available Edges</b>	<b>E</b> <b>M</b>



# edges and Dekton®

With Dekton®, the neutral bisque used as the base for each color will remain solid-colored and will display a honed finish along the edge's thickness.

Certain Dekton® colors are what is called **full body**, where one can observe a slight texture in the neutral bisque along the edge. **Nebbia** is one of these colors. You therefore obtain a slight texture along the thickness of the edge that is closer to the top, but not identical.



© Photo : Cuisine Idéale Mirabel | Measure, fabrication & installation : Granite Design

**NEURAL** (  Ultra-Compact ) | Espagne | Tranche : 130 x 63

A light cream-toned base with fine, pale veins that run through the marbling, creating a fascinating neural network that moves in the same direction.

**Characteristic**



**Variation**



Layout not recommended

**Finish**



**Resistance**

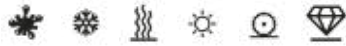

**Thickness**

20mm

12mm

8mm

**Applications**

indoor

outdoor

**Available Edges**



© Photo : Cosentino



© Photo : Cosentino

## nature and Dekton®

You fell in love with a natural quartzite or travertine, but the natural stone's care & maintenance has you rethinking your choice?

### Consider Dekton® !

Its nature-inspired designs, like **Neural** and **Sabbia**, replicate the beauty of the most elegant natural stones in the world, while offering you **unmatched ease of care.**

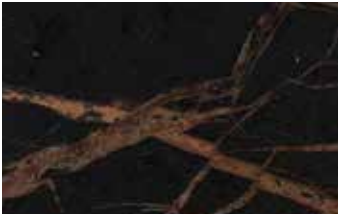

**LAURENT** **H**  
122 x 54 - 129 x 63



**MARINA** **V**  
129 x 63 & 126 x 55



**MORPHEUS** **V**  
129 x 63



**NEURAL** **M**  
129 x 63



**REM** **V**  
129 x 63



**SIRIUS** **H**  
124 x 56



**KELYA** **M**  
129 x 63



**NATURA** **P**  
126 x 55



**ARGA** **P**  
126 x 55



**TRANCE** **P**  
129 x 63

**FINISHES** Polished **P** Honed **H** Velvet **V**

Each Dekton® color has its own finish. A finish cannot be reworked to transform it into another finish. Certain colors created by Cosentino have the same pattern but different finishes (e.g.: Salina and Marina, Lucid and Morpheus, Limbo and Neural).

*when should you offer*  
**the vein flow**

When special attention must be given to a seam or joint to enhance vein continuity and flow. For example, when a project includes an oversized island with waterfall sides.



© Photo : Armoires Cordeau  
Measure, fabrication & installation : Granite Design

# particularities with Dekton®



© Photo : Cosentino

## SEAMS

[ TO BE CONSIDERED WITH DEKTON® ]

With Dekton® by Cosentino, we recommend adding a slight tile edge on joining pieces to minimize the risks of chips during install and make care & maintenance easier; while still maintaining an elegant look.

If your project includes large pieces, such as an oversized island, and that you wish to avoid the tile edge, inlays are a popular design element to add to your concept! They can be made out of metal, wood, or even in another contrasting stone color. Make sure that you explore these alternatives!

## what is a tile edge

The tile edge is a small bevel applied to either side of joining pieces, to create a small V-shaped groove.

It ensures quality installation and eases care & maintenance.

Tile Edge  
*polished bevel only*



© Photo : Atelier Jacob | Template, fabrication & installation by Granite Design



© Photo : Armoires Cordeau, Dekton® Arga  
 Template, fabrication & installation by Granite Design

particularities  
**with Dekton®**

## EDGE PROFILES

[ AND PATTERN/FINISH CONTINUITY ]

With Dekton®, because the pattern is printed on the surface of a neutral-colored bisque of high-quality ingredients, the vein continuity throughout the thickness is not often present (only a few Dekton® colors offer this possibility). By choosing the Eased edge, the **edge will be honed and of a solid color.**

To avoid this situation, choose the Miter edge border with a 45-degree assembly, which will enable veins and finish continuity, and you can choose the thickness you want!



Dekton® Arga  
 Eased edge around the cooktop area



Dekton® Arga  
 Miter Edge on island countertop

# particularities with Dekton®

## UKIYO TEXTURE

[ THE BEAUTY LIES IN SMALL DETAILS ]

The Ukiyo texture brings elegance with its pure, clean lines that play into a stone's complexity without overloading visual senses. Achievable on Dekton®, Silestone® and natural stones, it can be either purchased through Cosentino's available collection, or created custom-made through **GRANITEDESIGN**.

**Important : a 45° assembly is not compatible with this texture, but a tile assembly will create a distinctive, refined look.**

Photo : L'Œil Clinique optometrist  
Measured, fabricated & installed par **GRANITEDESIGN**

Island in Dekton® Rem, waterfall leg with tile assembly & Ukiyo texture on leg.

© Photo : L'Œil Clinique Optometrist  
Measure, fabrication & installation : Granite Design



# working with **DEKTON®**

## A few points to watch for

### VARIABLE PATTERN

Certain Dekton® colors are made to imitate natural stones. **In nature, a slab will contain various shades and contrasts in a random way. The same is true for Dekton®. A variation in tone and the presence of impurities is therefore possible.**

For Dekton® with veining or pronounced patterns, if the project includes seams in an L-shape, waterfall legs, backsplashes, etc., it is recommended to **add a layout viewing option** that allows you to see how the stone flows across the pieces and minimizes break in patterns in strategic areas. Still not what you had in mind? Consider offering the **Vein Flow!**



Here is an example of Dekton® Bergen, showing two options. Option 1 is preferable to option 2 (but the waste-factor must be considered.)



### SUPPORTS and cabinets

Any appliance (dishwasher, built-in ovens, microwaves) that can generate heat must have a top made of the same material as the cabinets. This will offer superior heat protection in these areas.

The countertop must always be placed evenly on a sound structure.

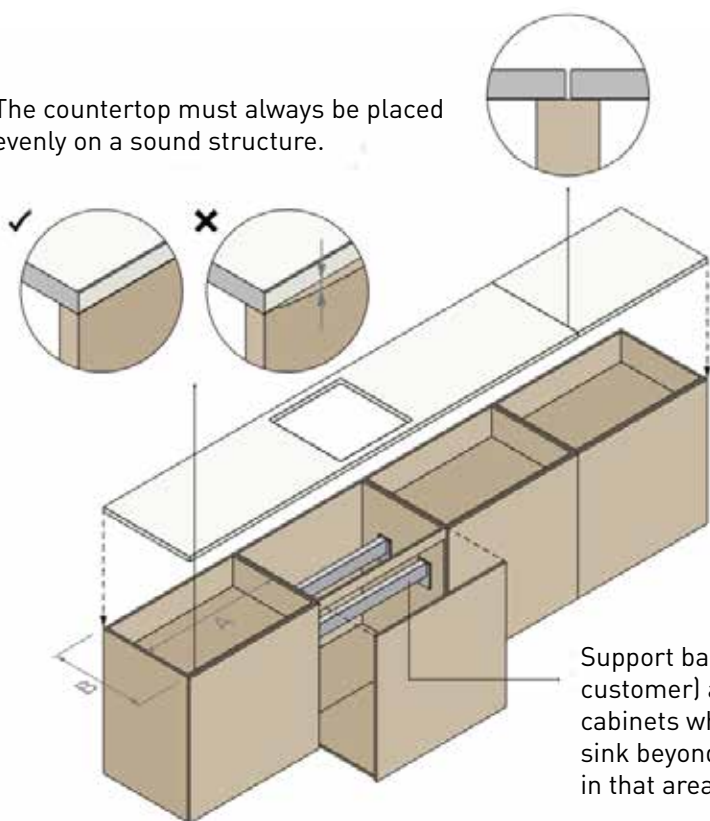

Support bars (supplied by the customer) are anchored in the cabinets when a heavy cooktop or sink beyond 24 inches is intended in that area.

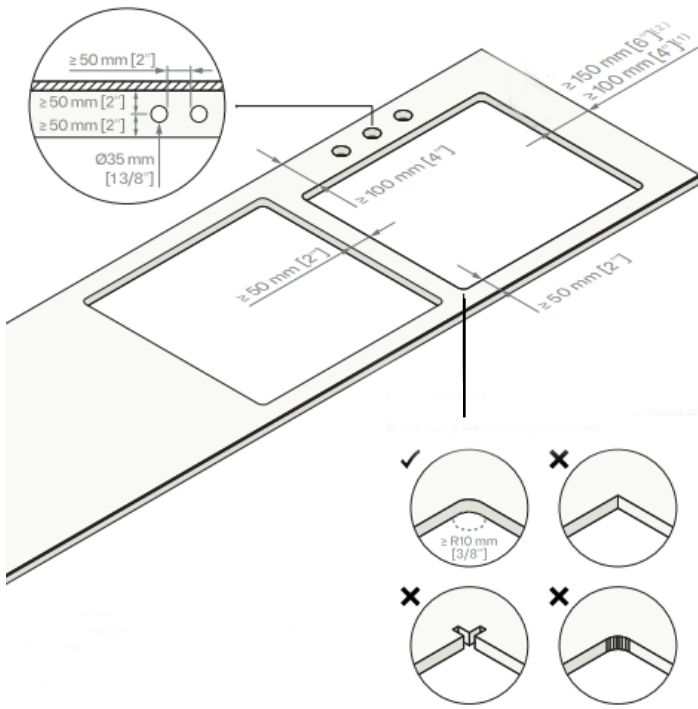

## CUT-OUTS

To minimize risks of breakage, minimum piece widths must be taken into consideration when planning cut-outs. **If an area is below the minimum required, it is best to create separate pieces that can be seamed.**

## INSIDE RADIUS

The minimum inside radius is 10mm for any cut-out in Dekton®. For sinks, it is recommended to use 20mm to increase the edge's resistance. **Any radius below the minimum will not be covered by Cosentino's warranty.**

## WATERFALL LEGS

With a material like Dekton® (and Silestone®), undersurfaces that are visible must be carefully planned to ensure an optimal quality installation.

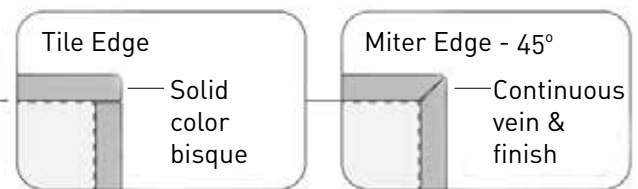
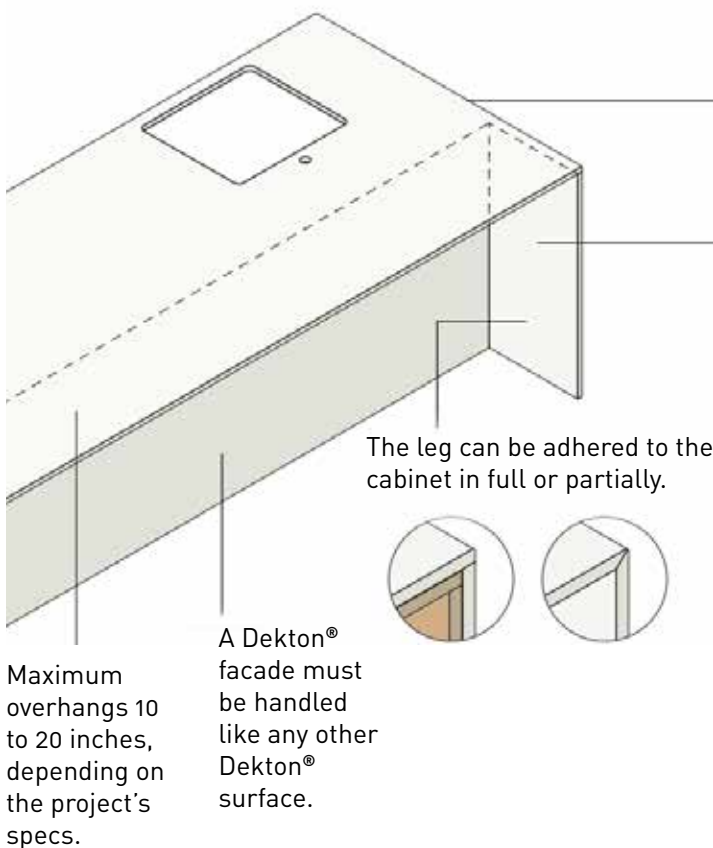

Undersurfaces can be visible depending on the project's specifications. In that case, consider:

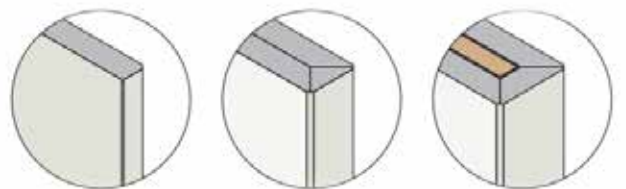

Smoothing to a honed finish to remove the branding.

The finish will never be like the top surface.

Do a return **without** cabinet.

The finish and pattern will be as the top surface.

Do a return **on** cabinet.

The finish and pattern will be as the top. The thickness will be larger than when done without cabinet.



# facets of **Dekton®**

## **Dekton® : when material becomes experience**

With Dekton®, the bathroom is transformed into a space of calm, clean lines, and sensory experience. Surfaces flow seamlessly from one to another, joints virtually disappear, and the material expresses itself through a fluid, almost architectural aesthetic, where every detail is thoughtfully considered.

Custom, enveloping showers, continuous walls and floors, precisely crafted large-format tiles, sculptural vanities, integrated fireplaces, Dekton® opens the door to a rare level of creative freedom. It allows for the design of cohesive, immersive spaces in which every surface naturally interacts with the next, achieving a subtle balance between design and functionality.

One of Dekton®'s greatest advantages lies in its non-porous nature. Completely waterproof, it resists moisture and temperature fluctuations, making it perfectly suited for demanding environments such as bathrooms. Fabricated from large, custom-cut slabs, it significantly reduces the number of joints, resulting in fewer areas prone to mold,

less day-to-day maintenance, and a faster, cleaner installation compared to traditional tiles.

**As an award-winning Dekton® fabricator**, we leverage innovation, technology, and the expertise of our teams to shape this material with its unique properties. In our industry, every project is an exploration: some creations push the limits of the material and present technical challenges that match our creative ambition. These challenges are an integral part of the process, they drive the precision, engineering, and craftsmanship required to deliver exceptional results. And when everything aligns, the outcome is always spectacular.

If you are seeking a space that is **inspired by nature's most beautiful stone**, marble, or industrial trends, if you value rich palettes of textures and refined finishes, Dekton® is the **material that will naturally align with this pursuit of excellence**.



More than a material, it becomes a **contemporary canvas**, designed to create durable, inspiring, and **profoundly timeless** spaces.

# edge PROFILES

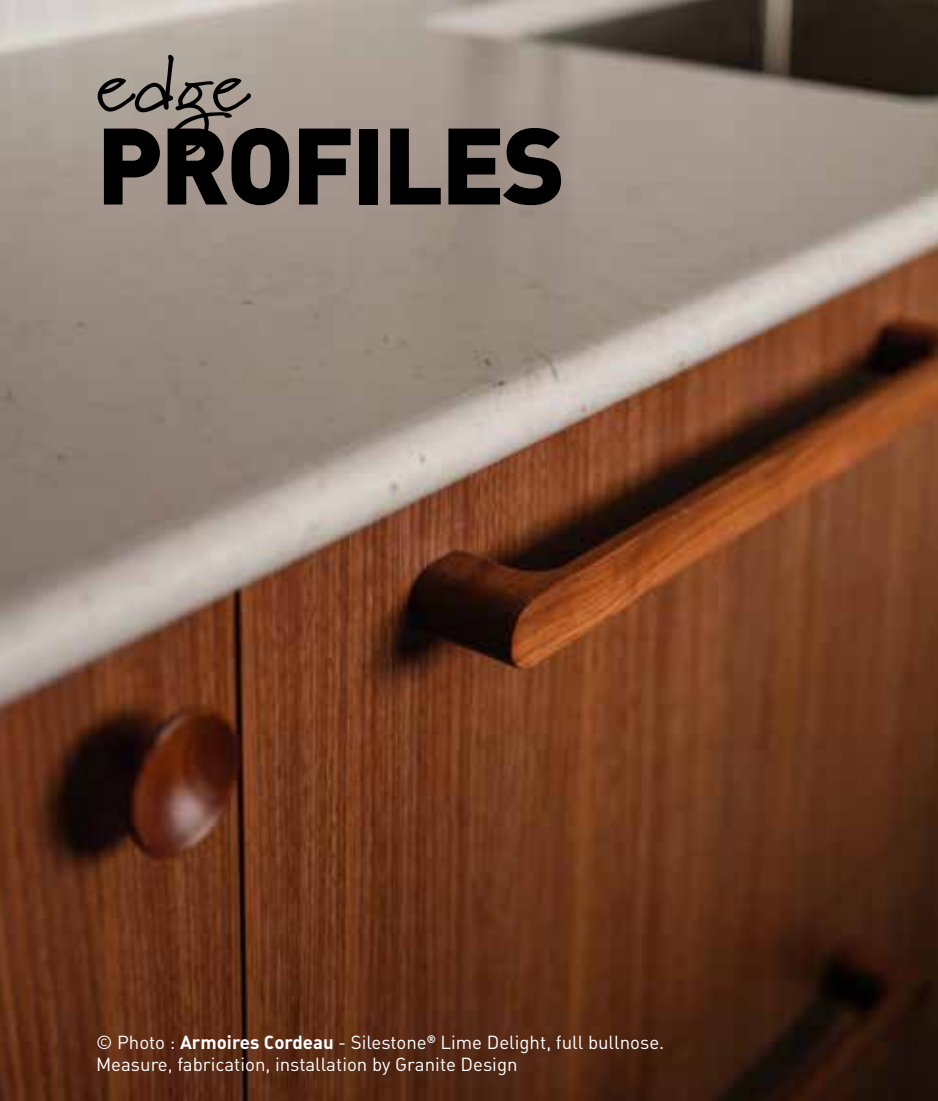

© Photo : **Armoires Cordeau** - Silestone® Lime Delight, full bullnose.  
Measure, fabrication, installation by Granite Design

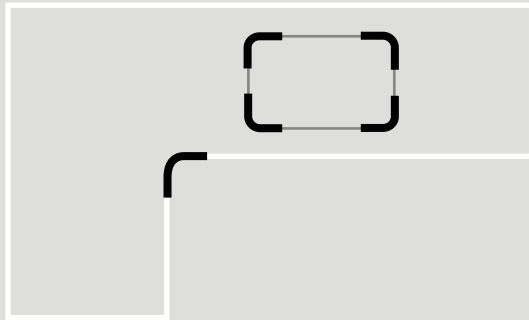

## INSIDE RADIUS

[ WHAT IS IT EXACTLY ]

An inside radius is found most often in sink surrounds or in an L-shaped piece that does not contain a seam.

## THE CHISELLED EDGE

[ WITH NATURAL STONE ]

This edge profile creates a rough organic look to natural stones, following the unique mineral structure. This edge is entirely made by hand.



**EDGE PROFILE Collection** Feasible thicknesses indicated below may vary. Contact your Granite Design expert with any questions.

**EASED** 3/4" 1-1/4"



**FULL BULLNOSE** 3/4" 1-1/4"

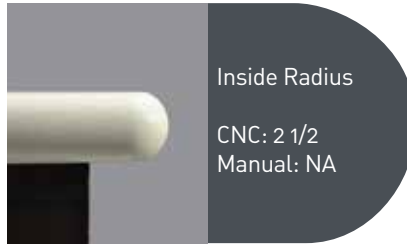

**BEVEL** 3/4" 1-1/4"



**BEVEL BULLNOSE** 3/4" 1-1/4"



**DOUBLE BEVEL** 3/4" 1-1/4"



**CASCADE** 3/4" 1-1/4"



**PENCIL** 3/4" 1-1/4"

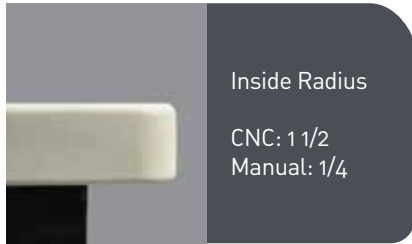

**HALF-BULLNOSE** 3/4" 1-1/4"

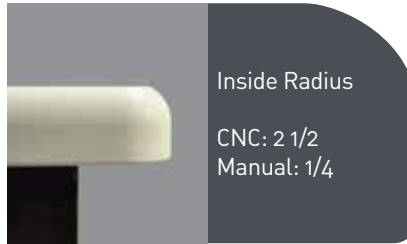

**HALFMOON** 3/4" 1-1/4"

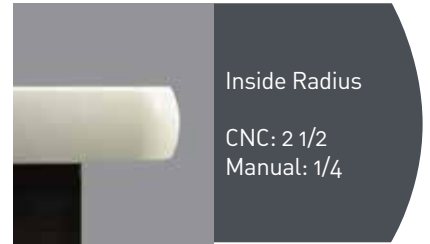

**DOUBLE OGEE** 3/4" 1-1/4"

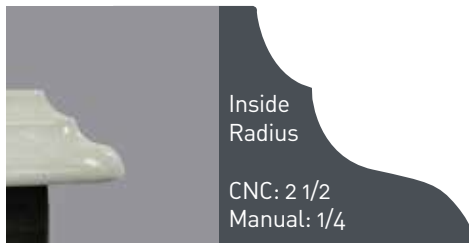

**ROMAIN OGEE** 3/4" 1-1/4"



**DUPONT** 3/4" 1-1/4"

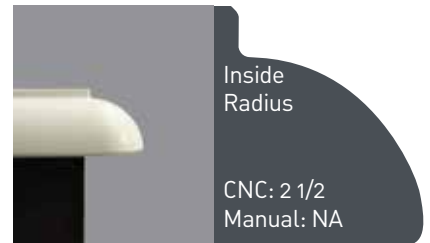

**BIG OGEE** 3/4" 1-1/4"

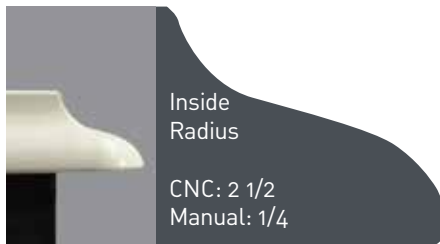

**SMALL OGEE** 3/4" 1-1/4"

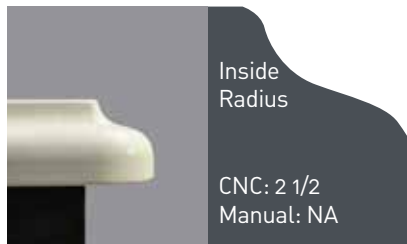

**SILHOUETTE** 3/4" 1-1/4"

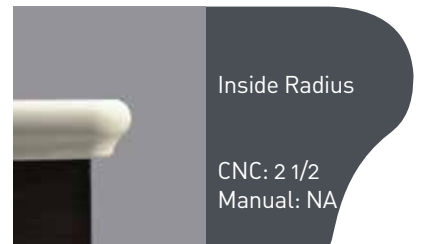

**SHARKNOSE** 3/4" 1-1/4"

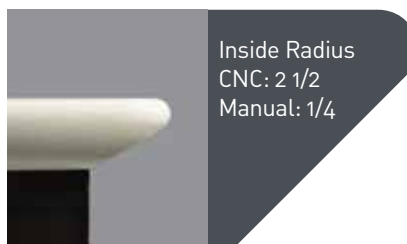

**MITRE - 45° ASSEMBLY** 3/4" 1-1/4"

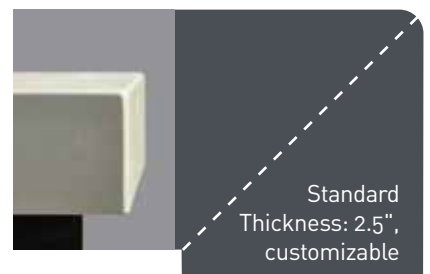

**IMPORTANT**  
dimensions, radiuses  
and bevels can vary  
depending on machine  
tolerances and the  
manual pressure applied  
by our artisans.

# value-added options



## SURFACE COVERING

[# OP1280]

The plastic film installed by our technicians on the surface signifies that the installation was in accordance with our high standards. Technicians take photos prior and after installing the film. **Quality assurance photos are taken before and after the film is applied (see photos in example).**

From that point, if another tradesperson tears the film and damages the surface; the customer can use the film as proof to request financial compensation that will be required to restore the surface by our artisans.

**IMPORTANT : this film is 4mm thick, it does not offer a protective barrier in itself. It simply indicates that at the time of install, the GRANITEDESIGN standards were met, and it contributes to providing elements of proof to support customers in the financial compensation process with the person who damaged the surface.**



**IMPORTANT**  
These products are **NOT covered by any warranty.**



## THE STONE CARE KIT

[#P911 FULL KIT | #P910 3-IN-1 CLEANER & CLOTH ONLY]

Professional grade products ideal for maintaining your natural stone surface!

### IMPREGNATOR (500ml | coverage: approximately 100 sq. ft.)

Silicone-base product that penetrates the stone without altering the appearance to boost the stone's resistance to stains & UV rays. Our team of experts can also do the application (charges apply).

1. Clean and dry the surface completely;
2. Protect the surrounding surfaces;
3. Apply the product using a brush, a paint gun or a paint roll;
4. Let penetrate 10 minutes, and apply a 2nd coat before the first coat dries.
5. Remove the excess. Clean and dry the surface.

### 3 IN 1 CLEANER (454 g)

Your friend for natural stones, ceramic, brass, and stainless steel! Do not overuse, as it will create a build-up. This product will clean, protect and add a little shine!

HOW TO APPLY : shake, vaporize a fine coat and polish using a clean microfiber cloth until the surface is dry.

WARRANTY

15  
YEAR\*

## THE EXCLUSIVE ANTI-STAIN TREATMENT

[#OP900]



Applied by our automated inspection line to ensure our worker's health & safety, but also guaranteeing an even application, a controlled curing time, and a second coat application, which will yield a superior quality barrier.

This treatment is intended for exotic natural stones.

Unlike sealers sold in stores, our exclusive GDGuard™ with long-lasting action penetrates deep into the stone and protects against food & beverage stains.



## ADVANTAGES

- ✓ Requires NO further sealing;
- ✓ Food Safe;
- ✓ Creates an effective barrier against liquids & oils;
- ✓ Resists heat;
- ✓ Is applied with precision (vs. other fabricators who use a rag to apply similar treatments) ;
- ✓ Creates a surface that requires no special maintenance. Simply clean the surface with our daily care method!

\* The 15-year warranty protects against food and beverage stains, applicable on purchase of granite and quartzite.

## THE CHIP MINIMIZER

[#OP1249]

Like we do with cell phone cases, this edge profile with rounded edges will minimize the risks of chips in the sensitive area around the sink.

### What is a Chip?

It is a piece of the stone that breaks away from the surface after an impact, leaving behind craters.

Depending on the type of stone and size of the crater, most chips can be easily restored with little visible impact, BUT travel and workmanship fees will apply, not to mention the time off that needs to be taken to be present for the service call, and chips are NOT covered by any warranty.

Think of offering this!





## SURFACE RIP-DOWN

[#OP1218]

All stones are available on the market in thicknesses considered "standard". In many cases, a same material can be available in different thicknesses, or depending on a project; a material can be ripped down during the fabrication process.

	1 1/4 in (3 cm)	3/4 in (2cm)	0.4 in (1cm)	12 mm	8 mm
NATURAL STONE	✓	✓	✓*		
MINERAL SURFACE	✓	✓			
ULTRA-COMPACT SURFACE		✓		✓	✓

\* Certain natural stones are available in 1cm, slabs are generally meshed and include fibre glass to make it safe for handling and fabrication.

**WHY RIP DOWN?** Depending on your project, here are a few frequent reasons :

BACKSPLASHES	To ensure proper faucet functioning For a more minimalist/clean look
FIREPLACE & WALL COVERING	To lighten the load for installers (better install quality) Minimize the weight on the structure
THRESHOLDS	To free up surrounding areas To align with the rest of the floor covering thickness
KITCHEN	To lighten the weight (ex.: RV kitchens) Create a more modern look

## SEAM SMOOTHER

Our inspection line validates the material's thickness, our fabrication equipment produces high quality cuts, our European seams are assembled by experienced technicians using a dual-vacuum system to create the nicest seams possible, **so why choose this option?**

- ✓ To add time to your installation that allows greater care and a full review with our technicians specifically for the seam area;
- ✓ To add peace of mind; as this option also includes the first service call for a situation relating to a seam following installation.

With or without the Seam Smoother, **GRANITEDESIGN** respects quality standards:

### QUALITY STANDARDS - related to a seam

Height between two pieces at a seam  
(can be visible and can be felt)

1/32"



Thickness of the seam between two pieces  
(including the microchip area)

1/8"



Industry standard



**WITH** seam smoothing  
the final result may vary depending on material.

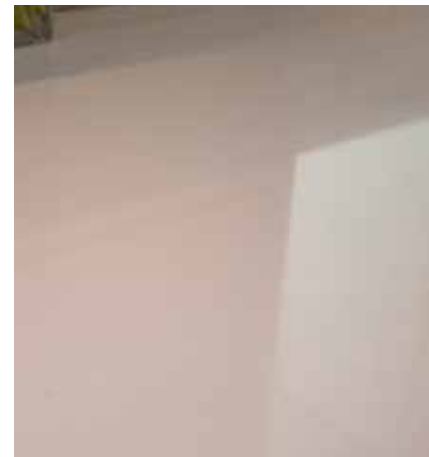

**1-YR  
WARRANTY**

Covers seam performance and undermount sink installation. Following 1 year, any ungluing, opening or seam popping related or not to structural change, misuse or abuse of the surface is not covered. The aesthetic aspect of a seam is never included in the 1-yr warranty, except if the seam does not respect industry standards. The silicone finishing between a countertop and a wall is not a seam and is never covered by the warranty.



## CUSTOM UNDERMOUNT CUT-OUT

[#OP1228 - KITCHEN | #OP1230 - VANITY]

The undermount cut-out is installed in overhang to ensure easy maintenance in areas that are prone to bacterial propagation. It also creates a cleaner look that takes into consideration the sink fabricator's tolerances.

### SPECIFICATIONS

- ✓ Cut and polished on our CNC machines;
- ✓ The eased edge profile is standard, but can be personalized with the Chip Minimizer, bevel, pencil, small ogee or Dupont edge;
- ✓ Overhang installation is recommended for a more pleasing and easy to care result;
- ✓ Generally has a 3/8" inside radius (will vary depending on chosen material and edge profile)

What happens to sink cut-outs?  
Find out at 0:38!



### OVERHANG - default

The countertop exceeds the sink by 1/8" to 3/16".

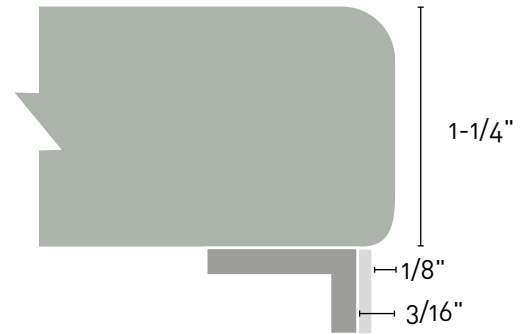

### FLUSH

Difficult to obtain perfect result, as sink makers have min/max tolerances in specs.

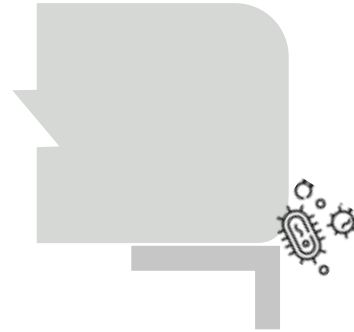

### REVEAL

Not recommended, the surround is visible and prone to bacteria accumulation.



## DRAINBOARDS

A drainboard will optimize space and offer an elegant solution in lieu of the ugly dish racks. With this option, water will trickle down, but do not expect a waterfall [the slope is not that intense!]

Models are

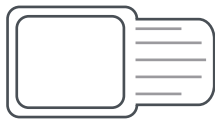
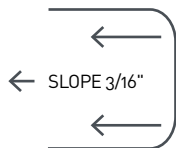

**SLOPED RECESS**

**FLAT RECESS WITH FLUTE**

**FLUTE**

**FLUTE + RING**

✓ Natural Stone ✓ Mineral Surface ✗ Dekton®

✓ Natural Stone ✓ Mineral Surface ✓ Dekton®\*

### PARTICULARITIES PER MATERIAL TYPE

**SOLID GRANITE & MINERAL SURFACE**

**EXOTIC NATURAL STONES (VAR. 3 & 4)**

**\*DEKTON®**

Good choice

Microfissures will be visible, change in color in flutes possible (through oxidation). Seal yearly.

Flutes will not have the printed design and will be honed. Will require more frequent cleaning.



# your options for backsplash



Photo : Taj Mahal antique  
Fabrication & Installation :  
Granite Design

○  
- CUSTOM-HEIGHT

○  
- STANDARD HEIGHT

○  
- FULL HEIGHT

## BACKSPLASHES

Particularly with exotic natural stones with high variation or mineral & ultra-compact surfaces with veins, **it is important to plan the backsplashes at the same time as the countertops, and offer the layout option.**

	STANDARD	CUSTOM	FULL HEIGHT
HEIGHT	Generally 4 in. Can be different, as long as it is the same height throughout all backsplash pieces.	Height to fit surrounding elements (windows, ceiling, etc.)	16 to 18 in. to fill the space between the countertop and upper cabinets
THICKNESS	1-1/4"	1-1/4" rip down option to 3/4" recommended	1-1/4" rip down option to 3/4" recommended
MAX LENGTH	48 - 60" (natural stone) 80" mineral & ultra-compact surfaces		
EDGE	Generally eased, but can be customized		
ADJUSTMENT	Adjustments on-site can be required to ensure a quality installation.		
SEAMS	Any seam in a backsplash will always be visible and perceptible to the touch. A slight tile edge will be included to facilitate installation.		

## SIDE SPLASHES

Creates a transition between an area with a full-height backsplash and surrounding walls. Here are some popular examples.

Side splashes are subject to the same specifications as backsplashes.



## THE TILE EDGE

Featured with full-height backsplash or wall panel projects (fireplace, shower, etc.), it ensures quality installation and eases care & maintenance. Depending on the project, our experts choose the appropriate tile edge.

Flat Tile Edge  
*polished edge*

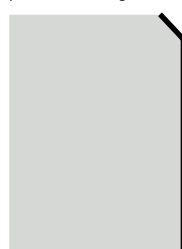

Tile Edge  
*polished bevel only*

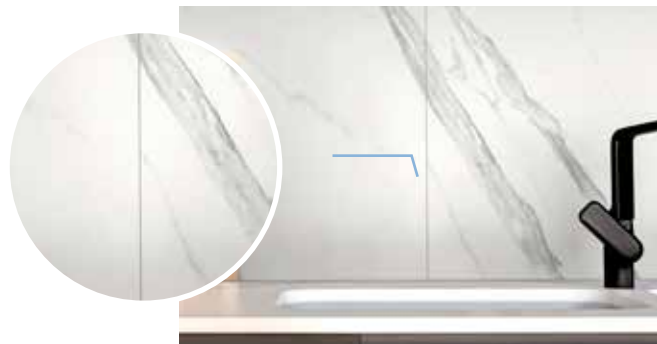
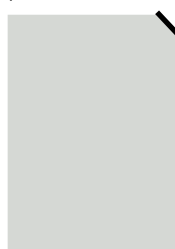

# your options for radiuses



Large radiuses are back, with the timeless Mid-Century-Modern style that is more popular than ever! Here is a radius sizing chart of the most popular options to help you better target customers' desires!

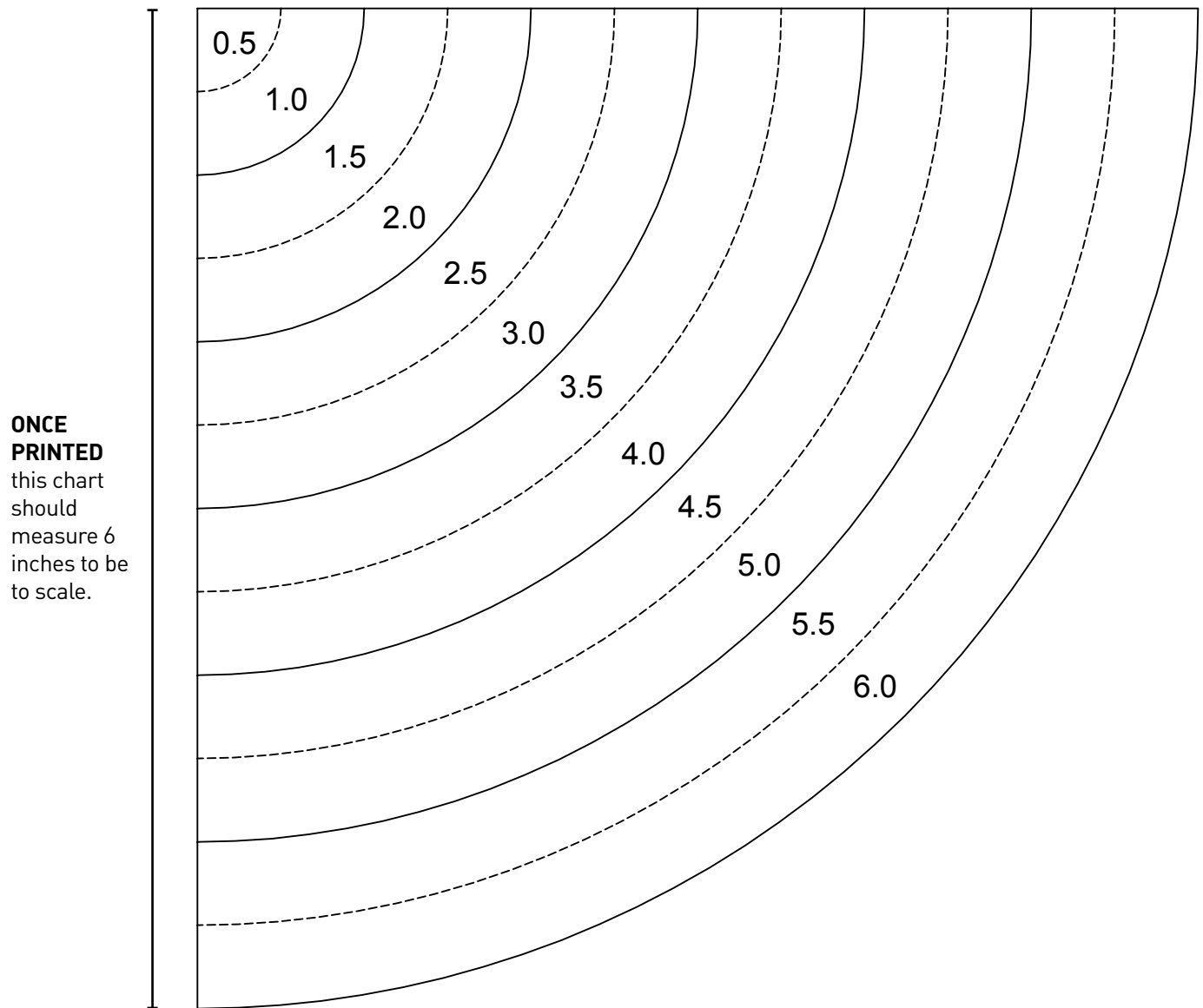

## ARCS & BUMPOUTS

[#OP1231]

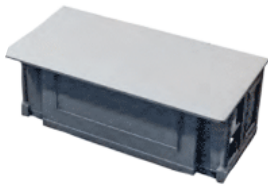

DÉPASSEMENT

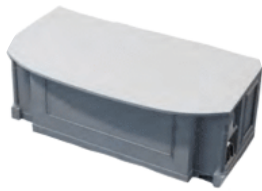

ARC



AVANCÉE



### SPECIFICATIONS

- ✓ Generally used in an island or in front of a sink;
- ✓ Material calculation must include the waste created by the cut;
- ✓ For overhangs and arcs, the standard overhang without support must be respected depending on the chosen material.

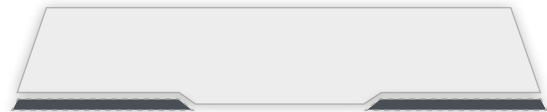

Ex. of material calculation that takes into consideration the waste created by the bumpout cut.

### COUNTERTOP OVERHANG

Standard countertop overhang without required support is generally between 10 and 12 inches. This can vary on the material's type and thickness. We give as general rule of thumb the 2/3 - 1/3 rule (2/3 supported by cabinets for 1/3 unsupported).

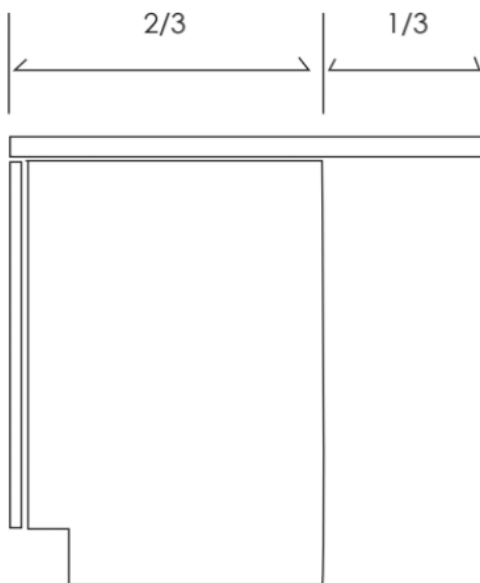

As soon as the unsupported surface exceeds that proportion, support is required.

In the event of a large overhang behind a sink or cooktop, a hidden support will be required and installed by our technicians. If the proportion beyond cabinets is considerable, it is possible that other support types (corbel, leg, brackets) are required.

**If your design includes brackets or other, they must be on-site for the measure.**

#### MAXIMUM OVERHANG WITHOUT SUPPORT

Granit <b>1 1/4 in.</b> <i>variation 1 &amp; 2</i>	15"
Exotic granite <b>1 1/4 in.</b> <i>variation 3 &amp; 4</i>	12"
Marble/Quartzite <b>1 1/4 in.</b>	12"
Soapstone <b>1 1/4 in.</b>	12"
Mineral Surface <b>1 1/4 in.</b>	12"
Ultra compact <b>3/4 in.</b>	10"

## BRACKETS AND OTHER SUPPORTS

Brackets and other supports (corbels, legs, metal invisible plates, etc.) are important to plan when an overhang exceeds the safe maximum width without support.

### SPECIFICATIONS

- ✓ The purchase is a customer's responsibility;
- ✓ The support must be in place, fixed to the cabinet for template (except for PerfectF.I.T.™ projects where they should simply be on-site);
- ✓ Installers will fix the top portion to the countertop, as that step is more delicate and requires taking the stone's unique nature in consideration.

BRACKET/CORBEL	LEGS	AVERAGE MATERIAL WEIGHT (per square foot)	
A 24-inch distance between each is recommended.	For overhangs of 18-in and more.	Natural Stone - 1 1/4 in.	18-20 lb
Ideally install support to the cabinet prior to template.	Must be sufficiently sound to support the stone's weight.	Mineral Surface - 1 1/4 in.	20-25 lb
	30-in distance recommended.	Ultra Compact - 3/4 in.	12 lb

## WATERFALL LEG

[#OP1259 - 45-degree assembly | #OP1260 - tile assembly]

This European trend is now mainstream. The 45-degree assembly offers a "seamless" look that wraps the surface. The tile assembly creates a visible junction, but will provide a cost-effective option with an elegant result.

### SPECIFICATIONS

- ✓ Leg sold per unit;
- ✓ Pieces are dry-fitted at the fabrication facility, and assembled on-site;
- ✓ Cabinets must be created to allow flexibility at installation (especially if there are legs on both end);
- ✓ Think of offering undersurface polishing when undersurfaces are visible. The polish will match the top's finish (for polished and honed stones), and for an antique stone, the undersurface will be honed.

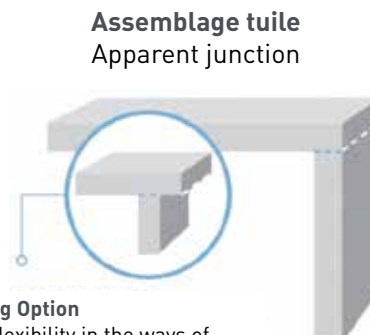

**Offset Leg Option**  
can add flexibility in the ways of using the space.



© Photo middle & bottom : Armoires Cordeau.  
Template, fabrication, installation by Granite Design.

## UNDERSURFACE POLISHING

When an undersurface is visible, we recommend offering the undersurface polishing, which will result in the matching the under surface's finish to the top (for the polished and honed surface). A top with an antique finish will have a honed undersurface finish.

Without this option, the surface underneath will be rough, may have meshing (for natural stones) or brand markings (for mineral & ultra-compact surfaces).

### OFFER THE OPTION when a project has

- ✔ A raised bar;
- ✔ A countertop with waterfall legs and an overhang;
- ✔ A countertop with an overhang with seating.



POLISHED UNDERNEATH



NON-POLISHED UNDERNEATH

## THE VEIN FLOW

When designing a concept, it can be good to add a vein flow option, but especially; it is important to prepare customers and manage their expectations, which are often too high (thanks to the Magazine Cover page effect, where most photos are edited to hide certain «flaws»).

The base price means that our team will plan each piece in a way that minimizes waste while offering the most pleasing result. **The Vein Flow option means that our team will prioritize vein fluidity even if it means purchasing more material and increasing waste on the project.** Even with the Vein Flow option, veins may not match up perfectly everywhere, but the result will be the best outcome possible.

### OFFER THIS OPTION when a project has

- ✔ A backsplash that is made of the same material as the countertop (especially if the chosen material has veins)
- ✔ Island with waterfall leg
- ✔ If the vein fluidity across different pieces is more important to the customer's eyes than the bottom line cost.



PROJECT WITH VEIN FLOW



✘ EXPECTATIONS



✔ REALITY

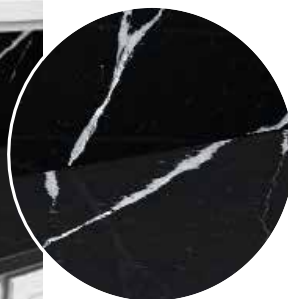

TOP VIEW  
as planned at cutting

SIDE VIEW  
once installed

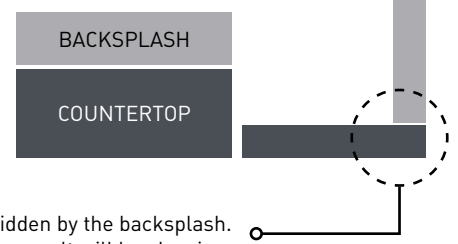

A portion of the countertop is hidden by the backsplash. Veins will be offset, but the result will be pleasing.

# offering the layout



This document is used to better imagine how a stone's pattern will run across the different pieces of a project. This service is recommended for natural stones, mineral and ultra-compact surfaces that have high variation. Additional fees may apply depending on the selected stone; make sure to ask about the option!

## IMPORTANT TO CONSIDER

- ✔ Certain factors in production can have an impact on the final result;
- ✔ When one observes the fluidity between countertop and backsplash pieces, a perfect match in veining is not achievable, as the saw blade and material thickness combined will result in vein offsetting. The result will remain aesthetically pleasing.
- ✔ With the basic layout option, production planning uses the material maximization technique to offer our partner distributors and their customers the most advantageous price possible. If the customer desires optimal fluidity than what is achieved through this option, consider the Vein Flow.



Installed  
**as planned!**

# creating an outdoor oasis

Dekton® Ceppo | Design : Armoires Cordeau | Template, fabrication & Installation : Granite Design



Dekton® Laurent floor tile, counter & backsplash Dekton® Sirius Template, fabrication & installation: Granite Design

## TAKING ADVANTAGE OF THE BEAUTIFUL SEASONS

Many materials are appropriate and will create an elegant and durable surface [yes, even with our Canadian winters!].

Whether it be to create a BBQ area, a full outdoor kitchen, a beautiful fireplace where we can chill, choosing the right material for a customer's budget and lifestyle is the first step.



Share this article with your customers!



- Ultra-compact (Dekton)
- Solid colored granite (variation 1, dense minerals, less resin)
- Exotic granites (variation 2, 3 & 4, mixed minerals, resined)
- Soapstone
- Quartzite & Marble
- Mineral Surface\*

❄️	☀️	🔥	❄️	😊
✅	✅	✅	✅	😊
✅	✅	✅	✅	😊
✅	✅	✅	✅	😊
✅	✅	✅	✅	😊
✅	✅	✅	✅	😊
✅	❌	❌	❌	😞

\* certain mineral surface options can be used outdoor, make sure to ask!

# choosing the right sink

Photo: Granite Design

## THE IMPORTANCE OF AN EDUCATED CHOICE

The sink is an important part of any concept. The size, positioning, accessories, available space, there are all factors that will guide the customer towards a choice that will suit their needs.

AVAILABLE SPACE		MATERIAL		INSTALLATION TYPE		
Cabinet Width	Maximum Sink Width	Type	Description	Type	Description	
24 in.	21 in.	Stainless	Simple to install & maintain; Antibacterial; May require special cleaners.	Undermount	Applied under the countertop; No visible border; Easy maintenance. <b>Must be left in place 24h before connecting the plumbing (under customer's responsibility).</b>	
27 in.	24 in.				Drop In	Visible border; Plumbing can be connected right after installation <b>(under customer's responsibility).</b> Silicone bead can be added <b>(under customer's responsibility).</b>
30 in.	27 in.					Apron
33 in.	30 in.			Custom Made Stone Sinks	Elegant, resistant & can be repaired; As resistant to scratches as a countertop; Cabinet must be able to withstand the weight; Require same type of care as countertops; Lifetime warranty against leaks.	
36 in.	33 in.					

### One bowl or two?

Typically, a single bowl is ideal for cozy spaces. However, there are oversized single bowls that are just as practical as a double bowl, choose something that you will like!



### MINIMUM CLEARANCE

at the front of the sink	at the back of the sink	at the back of the faucet hole
3.5 in.	5 3/4 in.	2 1/2 in.*

\* remember to consider the backsplash thickness into the calculations!

### IMPORTANT

Undermount sinks are installed by **GRANITEDESIGN** using a high-performance adhesive, and the adhesive performance is guaranteed for 1 year following installation. The technician will **NOT** reconnect plumbing, especially with undermount sinks as **the adhesive requires 24 hours to fully cure.**



## STAINLESS STEEL SINKS

Your pots and pans are no match for the durability of our sinks! Our collection offers high quality, durable models in different sizes, providing an option for every space.

Model availability can vary, validate with our team prior to ordering!

- ✔ Small single bowl models are ideal for intimate design layouts, bar areas or prep stations
- ✔ Single bowl models are ideal for smaller, more efficient spaces
- ✔ Double bowl models are best integrated in larger spaces

Locate our sink models and specs on our website!



### MSI STAINLESS STEEL SINKS



**18**  
GAUGE

#### 18G-1210

Ext. Dim.: 14-15/16" x 12-5/8"  
Int. Dim.: 12-15/16" x 10-5/8"  
Bowl Depth: 7"  
Strainer included.



**18**  
GAUGE

#### 18G-1618

Ext. Dim.: 18" x 16"  
Int. Dim.: 16" x 14"  
Bowl Depth: 8"  
Optional sink grid available.  
Strainer included.



**18**  
GAUGE

#### 18G-2318

Ext. Dim.: 23-3/8" x 17-3/4"  
Int. Dim.: 21-3/8" x 15-3/4"  
Bowl Depth: 8"  
Optional sink grid available.  
Strainer included.



**18**  
GAUGE

#### 18G-2321

Ext. Dim.: 23-1/4" x 21"  
Int. Dim.: 21-3/4" x 19"  
Bowl Depth: 8"  
Optional sink grid available.  
Strainer included.



**18**  
GAUGE

#### 18G-3018

Ext. Dim.: 29-7/8" x 18-1/16"  
Int. Dim.: 27-7/8" x 15-15/16"  
Bowl Depth: 8"  
Optional sink grid available.  
Strainer included.



**16**  
GAUGE

#### 16G-3219

Ext. Dim.: 32" x 19"  
Int. Dim.: 30" x 17"  
Bowl Depth: 10"  
Sink grid included  
Strainer included.



**18**  
GAUGE

#### 18G-40/60-3120

Ext. Dim.: 30-3/4" x 19-1/2"  
Int. Dim.: 23-7/8" x 17"  
Bowl Depth: 7-1/2" (L) & 9" (R)  
Optional sink grid available.  
One Strainer included.



**18**  
GAUGE

#### 18G-40/60-3120S

Ext. Dim.: 31-1/2" x 20-1/2"  
Int. Dim.: 29.18" x 18.08"  
Bowl Depth: 7"(L) & 9" (R)  
Optional sink grid available.  
One Strainers included.



**18**  
GAUGE

#### 18G-3118

Ext. Dim.: 32-1/4" x 18-1/2"  
Int. Dim.: 29-15/16" x 16-1/2"  
Bowl Depth: 8"  
Optional sink grid available.  
One Strainer included.



**18**  
GAUGE

#### 18G-60/40-3120

Ext. Dim.: 30-3/4" x 19-1/2"  
Int. Dim.: 28-3/8" x 17"  
Bowl Depth: 9" (L) & 7" (R)  
Optional sink grid available.  
One Strainer included.



**18**  
GAUGE

#### 18G-60/40-3120S

Ext. Dim.: 31-1/2" x 20-1/2"  
Int. Dim.: 29.18" x 18.08"  
Bowl Depth: 9" (L) & 7" (R)  
Optional sink grid available.  
One Strainer included.



**Our custom-made sinks have a lifetime warranty against leaks.**

## CUSTOM-MADE STONE KITCHEN SINKS

Fabricated in natural stones, mineral or ultra-compact surfaces, our sinks are built by artisans using the tongue & groove technique to the desired dimensions.

**NEW ENGLAND  
#MM1002**

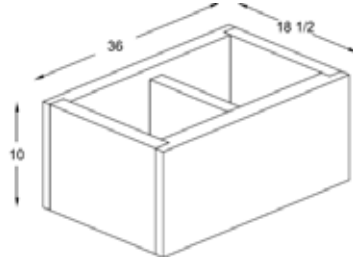

**BOSTON WILLIAM  
#MM1000**

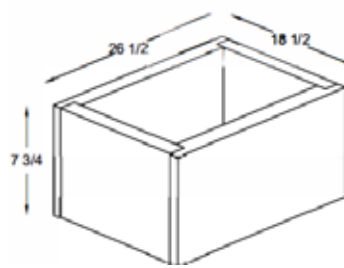

**CHICAGO  
#MM1003**

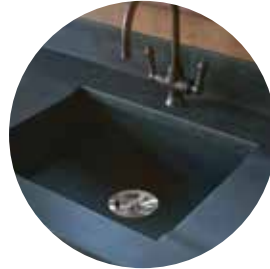
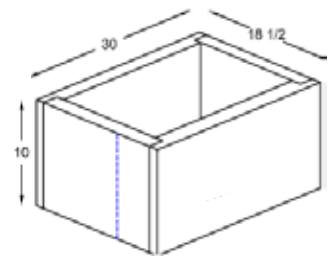

## INTEGRITY SINKS

Fabricated in mineral surfaces, these sinks offer all the same advantages that have made Cosentino's Silestone surface a worldwide leader; creating a durable and easy-to-maintain sink.

This option allows us to create a seamless look that is easy to install. The Integrity sinks are available in different colors and in three sizes :

**DUE (S)  
#MM1017**



14.56 x 13.38 x 5.9 in.  
37 x 34 x 15.5 cm

**DUE (L)  
#MM1018**



14.56 x 20 x 5.9 in.  
37 x 51 x 15.5 cm

**DUE (XL)  
#MM1019**



16.93 x 26.378 x 8.27 in.  
43.5 x 67 x 21 cm



**Locate our sink models and specs on our website!**

# upgrade your design with a vanity

Offering your customers the opportunity to maximize material by adding, along with a kitchen project, a vanity, shelf, table top, etc. is often cost-advantageous.

You have a small project, and are flexible on the stone selection? Contact us and ask about our best offers!



Photo : © Cosentino, Dekton® Danae

## WHITE PORCELAIN VANITY SINKS



### UOV 1512

Ext. Dim.: 14 1/2" x 17 3/8"  
Int. Dim.: 14 1/2" x 11 5/8"  
Depth: 6 1/4"

### UOV 1714

Ext. Dim.: 19-5/8" x 15 3/4"  
Int. Dim.: 17 3/8" x 14 1/8"  
Depth: 6-1/4"



### UOV 1813

Ext. Dim.: 18 1/2" x 13 13/4"  
Int. Dim.: 15 1/2" x 11 1/4"  
Depth: 6-1/4"

### UOV 2015

Ext. Dim.: 20 3/8" x 15 1/8"  
Int. Dim.: 17-3/4" x 12-3/8"  
Depth : 6"

## CUSTOM-MADE STONE VANITY SINKS

Whether it be natural stones, mineral or ultra-compact surfaces, each vanity sink is built by our artisans and assembled with great care to provide a high-quality product.

### ARMONY #MM1020

FEASIBLE IN 1 1/4-IN (3CM) & 3/4-IN (2CM) MATERIAL

QUARTZ  NATURAL STONE  DEKTON



#### Suggested dimensions:

30 in. x 12 in. x 7 in.  
(76.2 cm x 30.48 cm x 17.8cm)

### FONDO #MM1015

FEASIBLE IN 1 1/4-IN (3CM) & 3/4-IN (2CM) MATERIAL

QUARTZ  NATURAL STONE  DEKTON



#### Suggested dimensions:

42.25 in. x 9.75 in. x 5 in.  
(107.32 cm x 24.77 cm x 12.7 cm)

### PLAZA #MM1010\*

FEASIBLE IN 1 1/4-IN (3CM) & 3/4-IN (2CM) MATERIAL

QUARTZ  NATURAL STONE  DEKTON

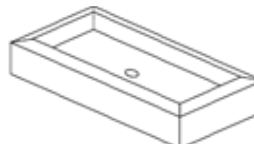

#### Suggested dimensions:

24 3/8 in. x 12 in. x 4 in.  
(61.91 cm x 30.48 cm x 10.16 cm)

\* models : #MM1010 - basin  
#MM1010 - integrated  
#MM1010 - undermount

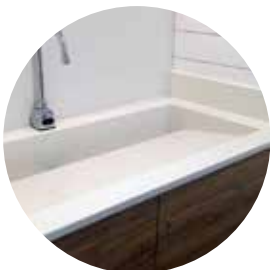

Our custom-made sinks have a lifetime warranty against leaks.



Our custom-made vanity sinks are quoted with our pop-up drain kit BS-03. If the customer wishes to use his own model, simply inform our team and ensure the desired model is on-site at template.



# THE UKIYO TEXTURE

[ THE BEAUTY LIES IN SMALL DETAILS ]

The Ukiyo texture brings elegance with its pure, clean lines that play into a stone's complexity without overloading visual senses. Achievable on Dekton®, Silestone® and natural stones, it can be either purchased through Cosentino's available collection, or created custom-made through **GRANITEDESIGN**.

When applied onto natural stones or mineral surfaces, the vein pattern will continue in the grooved line, whereas on Dekton®, the grooved line will reveal the neutral bisque's color (see page 77 for an example on Dekton®).

**Important : a 45° assembly is not compatible with this texture, but a tile assembly will create a distinctive, refined look.**

Photo : © Cosentino, Silestone® Jardin Emerald



## NEW INNOVATION !



**FREEPOWER - Transform your stone into a charging station!**  
**GRANITEDESIGN**, is a certified fabricator

Say goodbye to messy cables and limited charging spots! Transform your everyday surfaces into sleek, high-performance wireless charging stations! This sleek solution can be seamlessly installed under your countertop, night table, coffee table, vanity and more!

- ✓ Charge **multiple** devices at once
- ✓ **Easy to use:** just place and power up
- ✓ **Compatible** with all Qi-enabled devices
- ✓ Sleek, **discreet**, modern design
- ✓ App to **customize** the halo to your style!

# Our expert advice!

## HOW TO CALCULATE A SURFACE

Let's go back to basics. First, make sure to have the plan with dimensions in inches. Divide the plan into plain shapes (rectangles). Let's take this L-shaped countertop with 4-inch backsplash (identified with the ) and an eased edge profile (identified with the ):

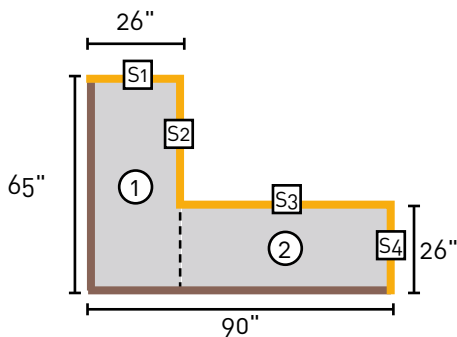

### CALCULATING SQUARE FOOTAGE

[for countertops & backsplashes]

1  $26 \times 65 = 1690 \text{ in.} / 144 = 11.7 \text{ SF}$

2  $64 \times 26 = 1664 \text{ in.} / 144 = 11.6 \text{ SF}$

#1:  $65 \times 4 = 260 \text{ in.} / 144 = 1.8 \text{ SF}$

#2:  $90 \times 4 = 360 \text{ in.} / 144 = 2.5 \text{ SF}$

**11.7 + 11.6 = 23.3 SF**

**1.8 + 2.5 = 4.3 SF**

**MATERIAL TOTAL : 27.6 SF**

### CALCULATING LINEAR FOOTAGE

[for edge profiles]

$26 + 39 + 64 + 26 = 155 \text{ in.} / 12 = 12.9 \text{ linear feet}$



#### WHY 26 INCHES?

Because a standard cabinet is 25 inches deep, and we recommend a 1-inch overhang.

## CALCULATING THE NUMBER OF SLABS

To estimate the number of slabs required for a project using maximization methods, here is a chart that provides the slab average size per material type. In these dimensions, we reduced a safety margin. This is why they differ from material fabricator websites (ex.: Cosentino). It is important to understand their sizes are gross, and edges are rarely perfect, the safety margin is necessary to cut away any imperfection (this is why you cannot plan a 120-inch wide piece in a slab that shows 120 inches wide..!)

DIMENSIONS DES TRANCHES			
Granite (average)		116 x 65	
Marble (average)		115 x 60	
Quartzite (average)		116 x 68	
Soapstone (average)		118 x 65	
Mineral Surface	Reg.: 119 x 53	Jumbo : 126 x 62	Jumbo + up to 129 x 63
Ultra-compact	Reg.: 122 x 54	Jumbo : 129 x 63 (valider la disponibilité)	



#### CAUTION

These dimensions will vary. Mother Nature does not create perfectly even blocks!

## SEAM TYPE AND PLACEMENT

The invisible seam does not exist! It's rock that is cut, then glued back together. However, the level at which the seam is visible will vary from one fabricator to another. **GRANITEDESIGN** prides itself on our superior quality seams :

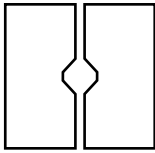

Joining pieces are fabricated with a V-Groove (for superior adhesive penetration).

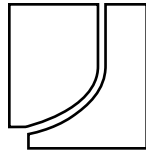

European seams are prioritized for an optimal result.

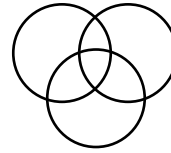

High quality color-matched adhesives are used.

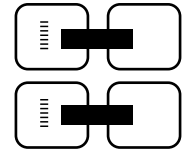

Double-action vacuum systems create a tight fit.

### The type of seam chosen

#### FLAT



Efficient, most popular with ultra-compact surfaces. With this material, we recommend a tile edge to minimize chips at installation.

This seam is often the default seam by other fabricators, for any material.

#### ADAPTED

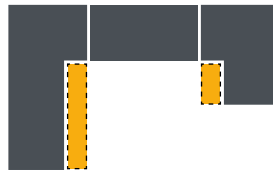

Can improve vein fluidity in a stone. The additional material (in yellow) is billable. Certain factors can impact the feasibility, discuss with our experts.

#### EUROPEAN



**This is the default seam offered by GRANITEDESIGN.**

It ensures a tighter fit, better performance, and confuses the eye, making seams less visible.

## SURFACE HARDNESS

Invented in 1812 by German mineralogist Freidrich Mohs, this scale still is used today to measure mineral hardness on a scale of 1 to 10 (1 being less and 10 being very resistant to scratches).

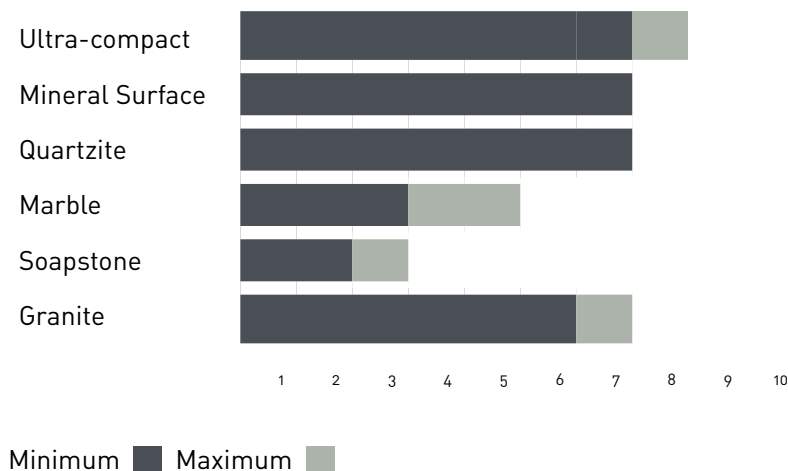

A material with a level between 2 and 2.5 will be scratched with your fingernail. Materials with a 5 will be scratched with a steel blade.

**Dare to do the test!**  
[but maybe not on a customer's countertops!]



## INSTALLING FULL HEIGHT CABINETS

Full height cabinets are coming back! Did you know that you do not need to schedule two separate appointments to have these cabinets installed? Simply allow the necessary gap between the bottom & top portion to fit your countertop material!

MATERIAL TYPE	SPACING
1 1/4 in. Natural Stone	1 3/8
1 1/4 in. Mineral Surface	1 3/8
3/4 in. Mineral, Ultra-compact or natural stone surface	7/8

**STEP 1**  
Cabinet installation



**STEP 2**  
Countertop installation



**STEP 3**  
Decorative finishing

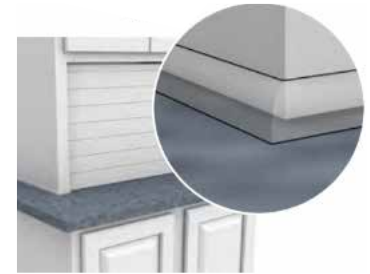

## STONE SURFACE INSTALLATION - INDUSTRY STANDARDS

Each project is unique, as is each installation space. Many variable factors will impact installation (home's age, wall & floor level, etc.). To ensure a high quality installation, it is possible that technicians adjust surfaces on site, and it is normal! There are also industry tolerances to consider:

**Seams :** a few epoxy coats can be required. A height difference between two joining pieces of 1/32 is tolerated.

**Level :** cabinets must be level and coplanar on a 10-foot run. Shims can be used. If the situation requires more correction, the technician will offer solutions; or will inform the customer that installation will need to be postponed to allow adjustments to the cabinets.

**Flush installation :** we do not recommend installing countertop flush with cabinet doors. A minimum of 1/4 inch overhang is required, and the optimal overhang is 1 inch.

**Spacing :** A 1/8 space between the countertop and the wall is required to allow for structural shift. We also leave between 1/8 and 1/4 inches between the top of the backsplash and top cabinets for full-height backsplashes for that same reason.

**Chips & scratches :** a surface can require adjustments at installation to correct superficial chips and scratches that can occur during transportation and piece handling. This is not a defect; **our technicians must be granted the opportunity to address the situation** to the customer's entire satisfaction. It is important to differentiate a scratch/chip from a microfissure (see page 20).

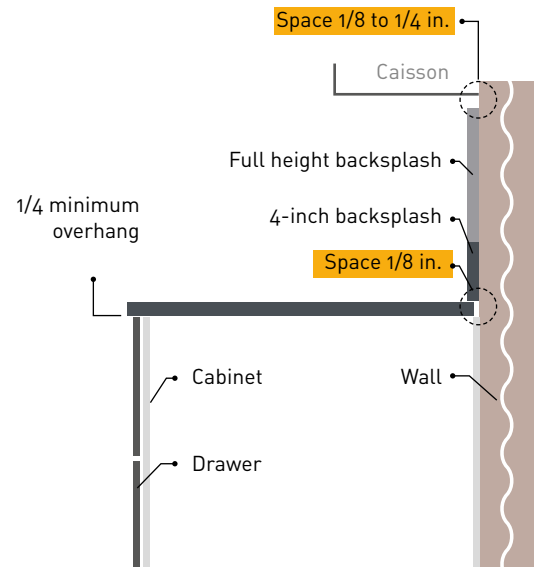

Side view - installing a countertop

### IMPORTANT

The silicone finishing is optional, to the technician's discretion, and is not a seam. A 2nd coat is often required and must be done by the customer.





# which material is best?

The short answer; there is no "better" material. It's all a matter of personal preference and the tolerance thresholds to different particularities that will help determine the best material for a customer's lifestyle.

							Characteristics often encountered	Outdoor Use
Ultra-compact (Dekton®)								
Solid colored granite (variation 1, dense minerals, less resin)								
Exotic granite (variation 2, 3 & 4, mixed minerals, resined)							  	
Soapstone								
Quartzite							 	
Marble								
Mineral Surface							 (dark stones)	

## CHART

### RESISTANCE

Materials are always resistant to, but are never BULLETPROOF to elements.

- Stain
- Scratches
- Heat
- Temperature change
- Acid
- UV Rays

### CHARACTERISTICS

Stones are subject to certain phenomenons that are not defects, but are part of what makes a stone unique.

- Microfissures
- Etching
- Pitting
- Variance in shine
- Requires more frequent cleaning
- Possible break of pattern at seam & junctions
- Edge design varies from top (neutral color & honed finish)



Discover a few tricks to maintain your countertops!





© Photo: Granite Design

# warranties offered by **GRANITEDESIGN**

<b>Undermount sinks</b>  Undermount sink installation adhesion is covered with a <b>1-yr warranty from date of installation.</b>	<b>Custom-Built Stone Sinks</b>  We offer a <b>lifetime warranty</b> on our custom-built stone sinks to protect against leaks.	<b>Seam performance</b>  Seam performance is covered by a <b>1-yr warranty from date of installation.</b>	<b>TREATED Natural Stones</b>  Natural stones are covered with a <b>15-yr warranty against food &amp; beverage stains.</b> (granite & quartzite only)	<b>Mineral &amp; Ultra-compact surfaces</b>  Refer yourself to documents available on fabricator websites (ex.: Cosentino)	<b>UNTREATED Natural Stones</b>  No warranties on food & beverage stains.
--	--	---	---	--	---

**NO STONE MATERIAL** is covered by warranties against cracks, fissures, scratches, discoloration, chips or any other damage that may be in relation to regular use, structural shift, prolonged exposure to elements, misuse, abuse, etc.



You have questions, or wish to place a service call? **1-866-761-8700**



Little quiz

# to break the ice!

Discover which type of stone best suits your customer's lifestyle!



## oops moments

Cleaning is necessary, but I often procrastinate and do cleaning last..!

I LOVE when everything shines! Cleaning makes me zen!



## What about your tolerance to imperfection?



## What about members of your household...?

My eagle eye sees EVERYTHING

I don't sweat the small stuff, but twice a year, I scrub the entire house from top to bottom!

I am zen, and prefer the more natural/rough look.

UMM... does it count if my furry friend jumps up on countertops?

We are models of perfection, just like me!

The **Dekton** and **mineral surface** will be great for you!

**Mineral surfaces, granite and quartzite** will suit your lifestyle.

All materials are open to you, but will be able to enjoy **Soapstone** to its fullest.

**Marble** is a possibility for you! We still recommend a honed finish to respect that stone's unique nature. It will be softer, and etching less visible (see page 7).

Discover the

Perfect **F.I.T.**™  
by GRANITEDESIGN

**COUNTERTOP INSTALLATION**  
**THE NEXT DAY**  
after cabinets are fully installed



Consult pages 16 & 17 for more details!